

# WELCOME HOME



**FIRST CLASS REISEMOBILE.**  
MADE IN GERMANY.



**MORELO**  
FIRST CLASS REISEMOBILE



**Dear friends!** Be inspired by elegant designs,  
sophisticated technological features and first-class equipment options.  
Take your travel dreams on holiday and discover the world of First Class Motorhomes!



**First Class – made in Germany.** Real motorhome enthusiasts come together in Schlüsselfeld, near Bamberg, to realise your dreams of luxury on wheels. We combine cutting-edge production technologies with traditional craftsmanship to create vehicles in an absolute class of their own. We strive to exceed your expectations in every regard – and we have only reached this goal when you are completely delighted with your first-class motorhome from MORELO.

Reinhard Löhner, Managing Director

Robert Crispens, Managing Director



# OUR FIRST-CLASS EMPLOYEES

---



## **The people behind the brand.**

An excellent motorhome cannot be created without an excellent team. From decal specialists to joiners, from construction engineers to mechatronics and design engineers, we are incredibly proud of our team of professionals and of each individual MORELO that rolls out of our plant.



# WHAT IS AT THE CORE OF MORELO?

**MORELO stands for first-class motorhomes that are among the best in the world.** A MORELO is always a statement of wanderlust, excellent comfort and superior quality. A MORELO means the feeling of being at home anywhere in the world. Or, in short, a MORELO is something truly special – Made in Germany.

This philosophy has helped us transform into one of the most successful luxury motorhome manufacturers in Europe in just a few short years. The friendly atmosphere, lively individuality, our determination, and our many years of experience all contribute to strengthening the brand. And while we may not have entirely expected this level of success in such a short time when we set out for the Caravan Salon trade fair in 2010 with just a few prototypes, we always had faith in our approach.

The combination of these factors is what makes MORELO truly special. But this alone is not what makes us unique. We did not set out to build motorhomes to get rich - we started doing this because there is nothing else we would rather do. After all, there is nothing better than to pack your belongings and get away for a few days - or, even better, a few weeks - and to travel through Scandinavia, discover southern Italy or take a trip to Portugal.

**This love for motorhomes is within us and in every MORELO.**



This overall picture describes what makes us unique.

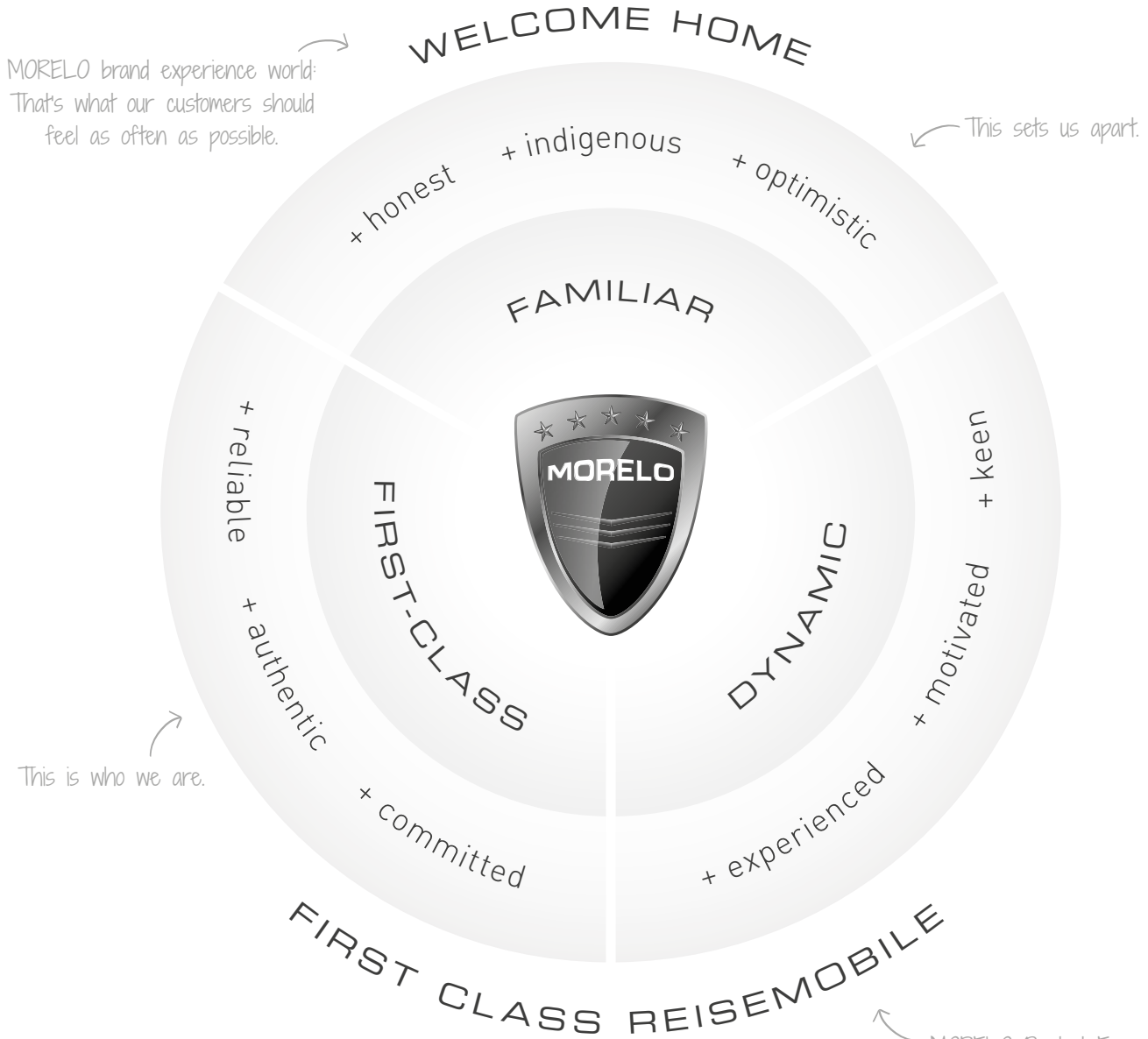

MORELO brand experience world:  
That's what our customers should  
feel as often as possible.

This sets us apart.

This is who we are.

We strive to ensure that everything  
we do meets this overall picture.

MORELO Product Experience:  
This is what our customers  
should find in all their facets.

### Technical specifications

	HOME	LOFT	LOFT LINER
	IVECO Daily	IVECO Daily	IVECO Eurocargo
Base vehicle	50 C 18	70 C 18	75 E 21 100 E 25 / 120 E 28
Cubic capacity	3,0 l	3,0 l	4,5 l
Max. power (kW/HP)	132 / 180	132 / 180	152 / 207
Length starting at	7,81 m	8,28 m	8,28 m
Width	2,35 m	2,40 m	2,40/2,50 m
Height	3,32 m	3,41 m	3,46/ 3,68m
Interior standing height	1,98 m	2,02 m	2,02 m
Driving licence class	C1	C1	C1 or C
Double floor height	366 mm	366 mm	420 mm / 480 mm
Fresh water / grey water tank capacity (ca.)	240 l / 200 l	300 l / 200 l	360 l / 250 l
Black water tank capacity (ca.)	□ 200 l	□ 200 l	□ 250 l
Car garage option	×	×	×
Price from	186.450,00 €	221.750,00 €	266.100,00 €

### Standard equipment/optional extras

Toilet with fixed tank	□	□	□
Floor heating	□	□	□
Air conditioner in cab	□	□	■
Engine heat exchanger	□	□	■
LED reversing lights	□	□	■
Flush windows in the cab	×	■	■
Heki 3 in living room	□	□	□
Entrance area with 2 drawers	×	×	■
Top Class cabin door	×	□	■
Premium bathroom	×	×	○
Dashboard with ambient lighting, refrigerated compartment	□	■	■
Premium cockpit	□	■	■
Wheel trims	□	□	□
Air-suspended swivel seats	□	□	□
Front / rear axle air suspension	□ / □	□ / □	○
Automatic gearbox	□	□	■

PALACE	PALACE LINER	PALACE LINER	EMPIRE LINER	EMPIRE LINER	GRAND EMPIRE
IVECO Daily	IVECO Eurocargo	Mercedes-Benz Atego	Mercedes-Benz Atego	Mercedes-Benz Actros	Mercedes-Benz Actros
70 C 18	100 E 25 or 120 E 28	924 L to 1530 L	1230 L or 1530 L	1840 L or 1846 L	1853 L
3,0 l	6,7 l	7,7 l	7,7 l	10,7 l	12,8 l
132 / 180	185 / 252	175 / 238	220 / 299	290 / 394	390 / 530
8,69 m	8,99 m	8,99 m	9,65 m	10,05 m	10,45 m
2,40 / 2,50 m	2,50 m	2,50 m	2,55 m	2,55 m	2,55 m
3,49 m	3,61 / 3,72 m	3,61 / 3,72 m	3,76 m	3,86 m	3,86 m
2,06 m	2,06 m	2,06 m	2,10 m	2,10 m	2,10 m
C1	C	C	C	C	C
420 mm	480 mm	480 mm	480 mm	480 mm	480 mm
360 l / 250 l	360 l / 250 l	360 l / 250 l	410 l / 280 l	410 l / 280 l	410 l / 280 l
250 l	250 l	250 l	280 l	280 l	280 l
□	□	□	□	□	■
262.100,00 €	320.050,00 €	343.250,00 €	448.150,00 €	523.750,00 €	705.800,00 €
■	■	■	■	■	■
■	■	■	■	■	■
■	■	■	■	■	■
■	■	■	■	■	■
■	■	■	■	■	■
■	■	■	■	■	■
■	■	■	■	■	■
■	■	■	■	■	■
■	■	■	■	■	■
■	■	■	■	■	■
■	■	■	■	■	■
■	■	■	■	■	■
■	■	■	■	■	■
■	■	■	■	■	■
□	■	■	■	■	■
□	□	□	■	■	■
□ / ○	■ / ■	○ / ■	■	■	■
□	■	■	■	■	■

■ Standard equipment    ✕ Not available  
 □ Special equipment    ○ See price list









# MORELO HOME





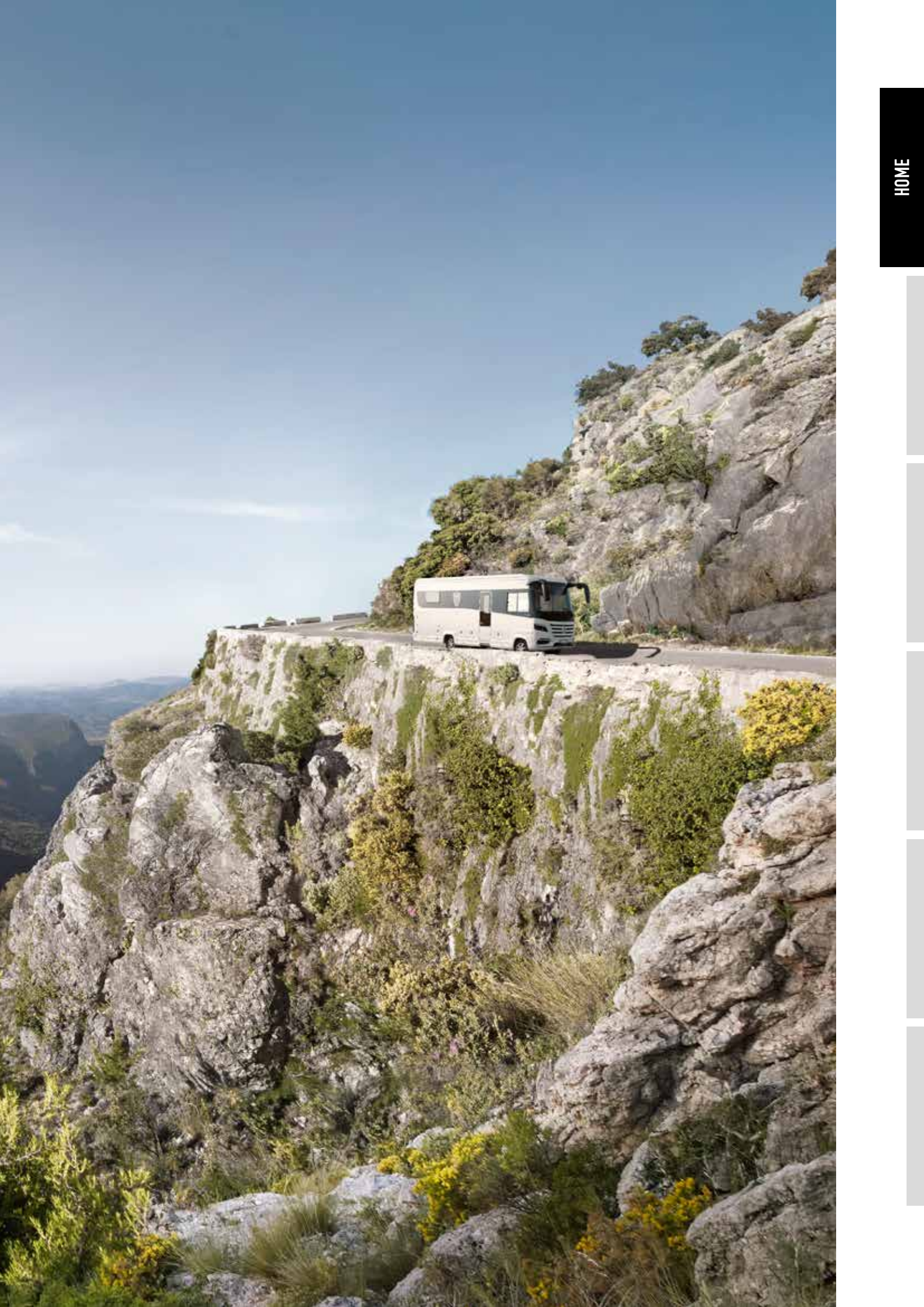





# WELCOME HOME

---

**Anybody who travels a lot enjoys being at home.** And the comfort it offers.

The MORELO HOME surrounds you with luxury and gives you a home on the move.

It gives you the freedom to be untethered, to travel to the most scenic locations, to reach new destinations, to make new discoveries. And to feel at home every step of the way.

**Nobody feels neglected in a MORELO.** With body lengths starting at 7.81 metres, the HOME model offers everything the heart desires for travelling in luxury: the first-class "WELCOME HOME" feeling paired with 180 bhp of driving pleasure. Even in our smallest MORELO, you are guaranteed to fully experience the MORELO style of travelling.

- ✚ External adhesives in black
- ✚ Turbo diesel engine
- ✚ 90-litre fuel tank



**TECHNICAL SPECIFICATIONS (excerpt)**  
 Chassis: IVECO Daily 50 C 18  
 Emission class: EURO VI e  
 Engine: 3.0 l  
 Power: 132 kW / 180 HP  
 Gross vehicle weight rating: 5,600 (5,800) kg

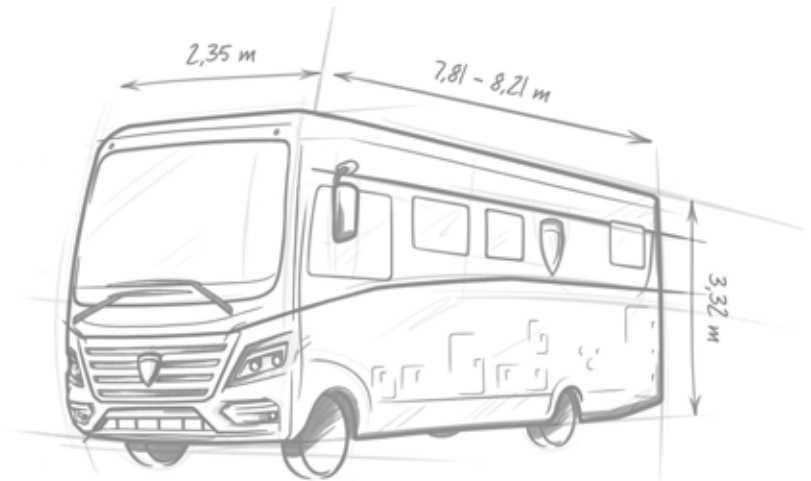





# GREATNESS IS IN THE DETAILS

---

**Even our smallest model is big where it counts.** The spitting image of its MORELO siblings, it takes just one look at the body and new front end to know that this is a MORELO. Compared to the LOFT, this model is more compact with a slightly lighter chassis, but it has the same impressive 42 mm-thick walls and outstanding insulation characteristics. That is anything but ordinary in this class. Except, of course, for a MORELO.





- ✚ MORELO look
- ✚ IVECO chassis
- ✚ Rear-wheel drive
- ✚ 42 mm roof and wall thickness
- ✚ Body free of thermal bridges
- ✚ Underbody free of corrosion-prone materials and wood



## CONVENIENT CONTROL CENTRE

---

**First-class travel and living comfort** comes from the HOME's cockpit, which features a lavish amount of space, a standalone instrument panel and thorough attention to every detail, such as the bus-style wiper system and exterior mirrors. The removable leather steering wheel (optional) makes it easy to turn the driver's seat, allowing it to be integrated into the living room. The raised seating position creates an excellent panoramic view.





- + Removable steering wheel (optional)
- + Swivel pilot seats
- + Large passageway
- + Panorama windscreen



# MORE ROOM FOR LIFE

---

**Bigger inside than it is outside?** It only seems that way. Despite its compact dimensions, the HOME offers much more room to move about than comparable vehicles thanks to the special MORELO furniture design. The comfortable and upholstered furniture, the level living room floor which stretches throughout the entire vehicle and plenty of first-class extras mean the HOME has everything that defines a MORELO.





- ✚ Interior that feels truly immense
- ✚ Optimal space utilisation
- ✚ Level living room floor
- ✚ Multifunctional table
- ✚ High-quality materials
- ✚ High-quality cushions



# ONE BEAUTIFUL KITCHEN

---

**What does a kitchen need to make you feel at home?** Exactly what we have fitted it with in the HOME. The HOME's kitchen provides everything necessary to make first-class cuisine on the go, and in one space-saving package: A high-performance three-burner gas hob, a sink located for perfect ergonomics and plenty of stowage space for everything that belongs in your fully equipped kitchen.





- + Three-burner hob
- + Drawers with soft close
- + Large stowage spaces



# A GOOD MOOD TO START THE DAY

---

**Enjoying the comfort of your own bathroom** provides a happy start to your day of travel. And a final stop full of relaxation before you head to bed. The bathroom in the HOME gives you every creature comfort you could never do without at home. The partitionable bathroom area features a separate toilet stall for privacy. The large shower features a real glass door and lets you enjoy a refreshing start to every day. The feeling of home.



- + Partitionable bathroom area
- + Separate toilet room
- + Spacious shower cubicle
- + Shower door made of real glass





# MORE ROOM FOR BEAUTIFUL DREAMS

---

**Sleeping in the HOME is more than spending the night just anywhere.** The two bed variants with spring system, multi-zone cold foam mattress and adjustable head sections let you drift off to sleep in bliss. As the moon slowly rises and the starry sky twinkles through the roof window above, you can let the events of the day drift through your mind as you begin to look forward to tomorrow ... Dreaming in a HOME is a wonderful experience. What are you still waiting for?



**FRONT-TO-BACK BED**

The front-to-back bed maximises your available space and is available as a double bed or two separate beds.

Premium size: **Two times approx. 103 x 200 cm**

**QUEEN BED**

The queen bed is accessible from both sides and provides enough room for two additional wardrobes.

Convenient size: **approx. 150 x 200 cm**

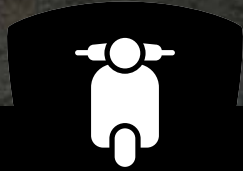

## PLENTY OF ROOM FOR THE LITTLE DETAILS

---

**Don't fret about your luggage.** You can be generous when loading your HOME since the immense stowage spaces always have a little room left over for this and that. The scooter garage in the rear offers ample space for two-wheelers or large pieces of luggage. Optimally located drawer systems and shelves, practical storage boxes in the side bench, plenty of stowage space in the intermediate floor: Even a few extras can find room without any problems.





- + Generous 366 mm intermediate floor height
- + Large doors to the stowage area
- + Through-loading option in the front stowage space
- + Scooter and bicycle garage







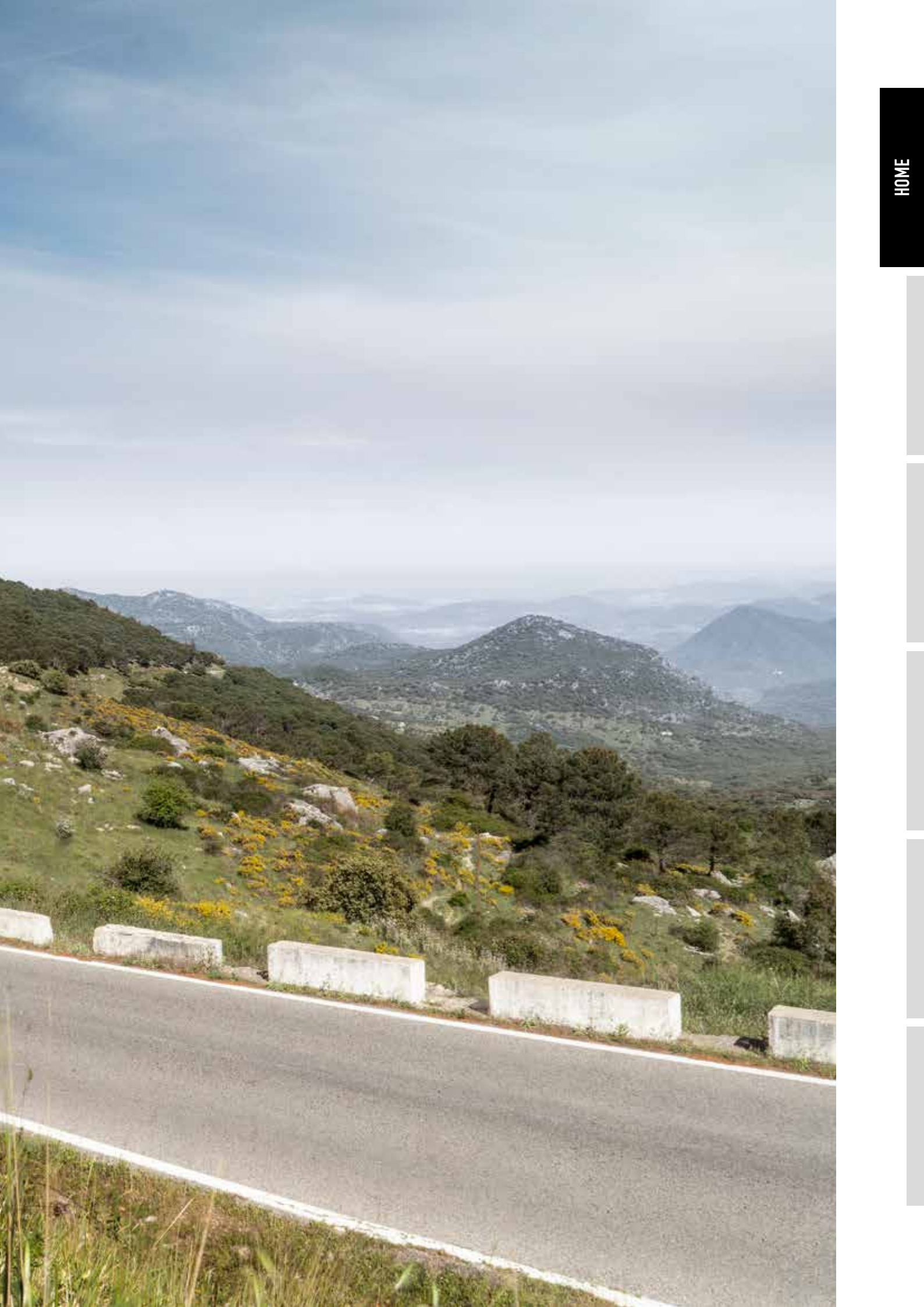



# MORELO LOFT

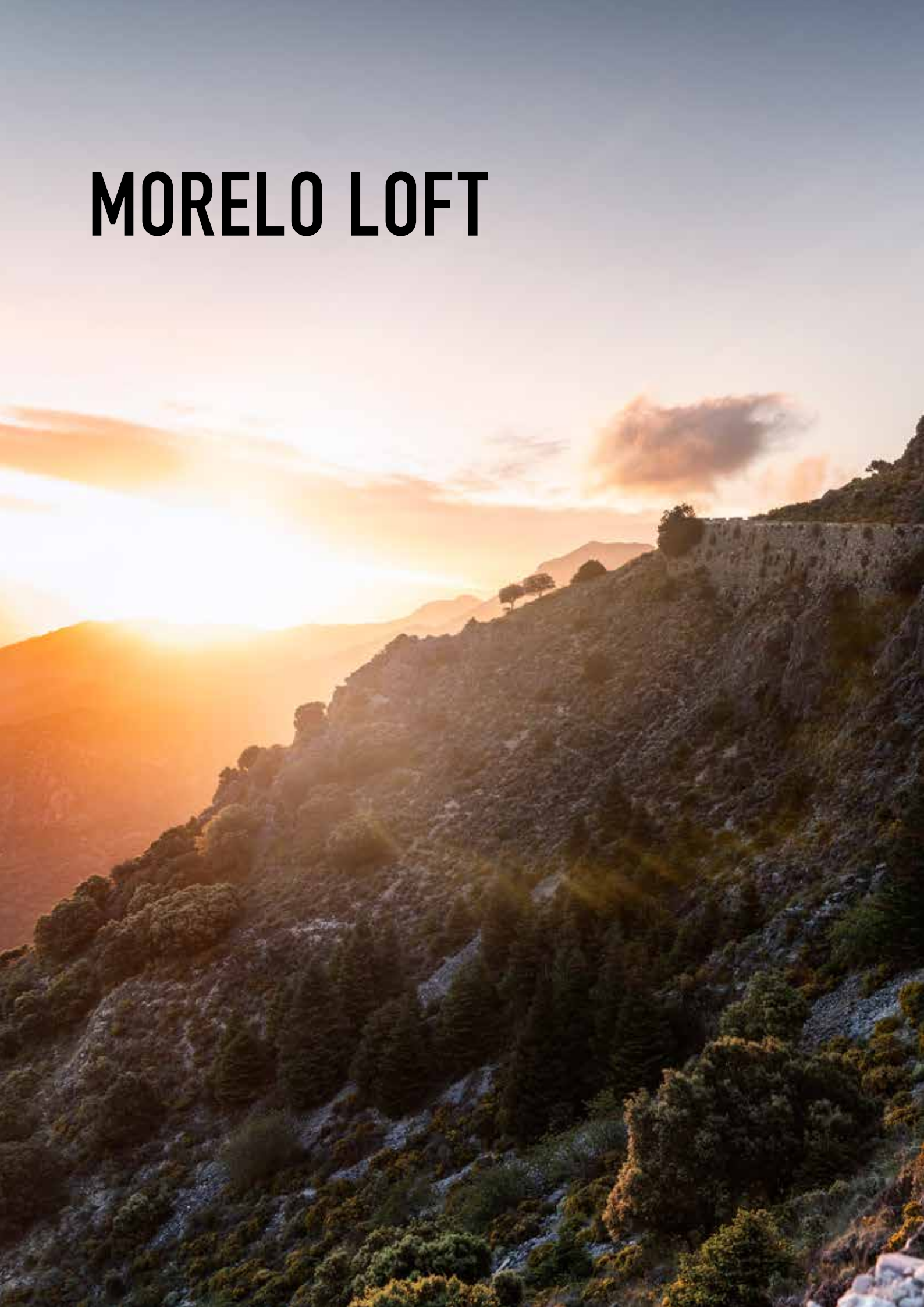









# APPEALING APPEARANCE

---

**A little bit more of everything.** Even the standard equipment on the new MORELO LOFT is very impressive: More load capacity thanks to a stronger chassis, a 3 litre engine with more torque, 2.4 m width for even more space in the living room. Excellent quality and first-class convenience combined with a compact look and versatile mobility.



**More space, more possibilities.** Choose from six models of your favorite and customise your LOFT individually according to your preferences. Only when you feel "WELCOME HOME" we have accomplished our mission. That's our way of showing size.

- ✚ Rear wheel drive with twin tires
- ✚ Electronic anti-lock braking system (ABS)
- ✚ Mechanical 6-speed transmission
- ✚ 2,4 metres external width



**TECHNICAL SPECIFICATIONS (excerpt)**  
 Chassis: IVECO Daily 70 C 18  
 Emission class: EURO VI e  
 Engine: 3.0 l  
 Power: 132 kW / 180 HP  
 Gross vehicle weight rating: 7.200 (7.490) kg

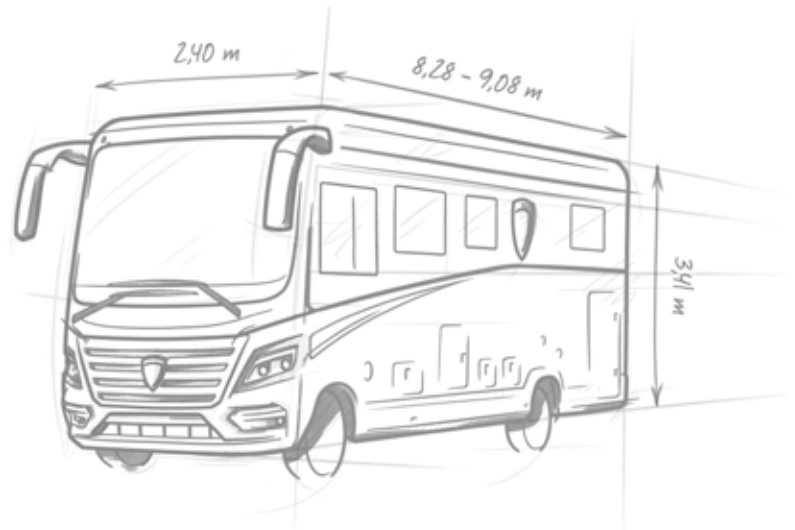



# STRIKING LOOK

---

**Unmistakably MORELO.** That is the look of the LOFT from its best side. Which is any side. The characteristic front section and optional matte-black carbon design emphasise the refinement of the dynamic look. The bus-style exterior mirrors provide optimal rear visibility and the perfect visual flair to the front of the LOFT. LED daytime running lights set the course and ensure you are seen. Even without them, the LOFT is hard to miss.





- ✚ Classic MORELO look
- ✚ Bus-style exterior mirrors
- ✚ LED daytime running lights
- ✚ Fog headlamps with passive cornering light
- ✚ Awning integrated into roof profile
- ✚ Extra-wide entrance door



# MORELO LOFT LINER





LOFT LINER





# THE FIRST IMPRESSION COUNTS

---

**And every other impression of the LOFT LINER is well worth it, too.** There is only one standard for this vehicle: first-class. Wherever your next journey takes you, you can always rely on the MORELO LOFT LINER. And that really is a fantastic feeling.

**The new MORELO LOFT LINER offers more of everything.**

As the base model in the “Liner” class, it uses an IVECO Eurocargo chassis to provide first-class comfort, while engine options with up to 281 HP ensure you have sufficient power for even the most difficult routes. Some say that “the journey is the reward”, and this certainly applies to the MORELO LOFT LINER.

- ✚ Turbo diesel engine, with rear wheel drive
- ✚ Differential lock
- ✚ Automatized transmission
- ✚ Numerous safety systems already as standard
- ✚ Engine heat exchanger
- ✚ Air conditioning in driver's cab



**TECHNICAL SPECIFICATIONS (excerpt)**  
 Chassis: IVECO Eurocargo  
 75 E 21 | 100 E 25 | 120 E 28  
 Emission class: EURO VI e  
 Engine: 4.5 l / 6.7 l  
 Power: 152 kW / 207 HP  
 185 kW / 252 HP | 207 kW / 281 HP  
 Gross vehicle weight rating: 7,490 (7,800) kg  
 10,000 kg | 11,990 kg

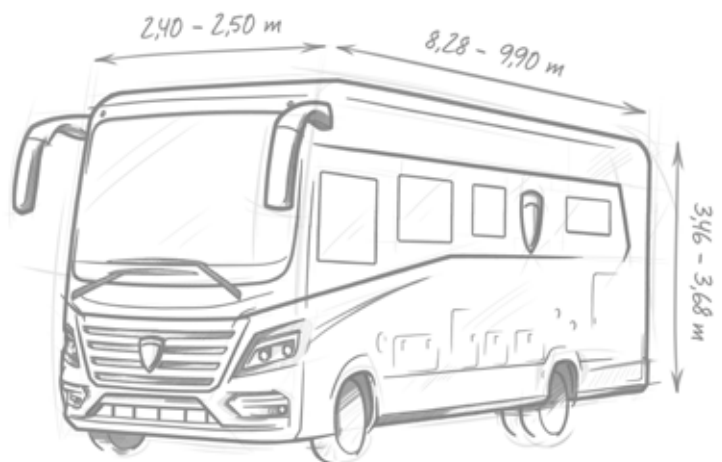





# ELEGANT APPEARANCE

---

**It is often said that it is what is on the inside that counts.** While this is true, the exterior of the MORELO LOFT LINER is also outstanding. Its appearance makes it apparent that this is an unparalleled first-class motorhome. The striking MORELO design elements are a clear statement of aesthetics and good taste. Being superficial every now and again is by no means a bad thing.





- ✚ Optimized noise insulation of engine compartment
- ✚ Premium cockpit
- ✚ LED daytime running lights
- ✚ Side walls in ALU-RTM-ALU sandwich design, smooth and high-gloss
- ✚ Awning integrated into roof profile
- ✚ Extra-wide "TOP class" entrance door
- ✚ Double floor height: 420 mm



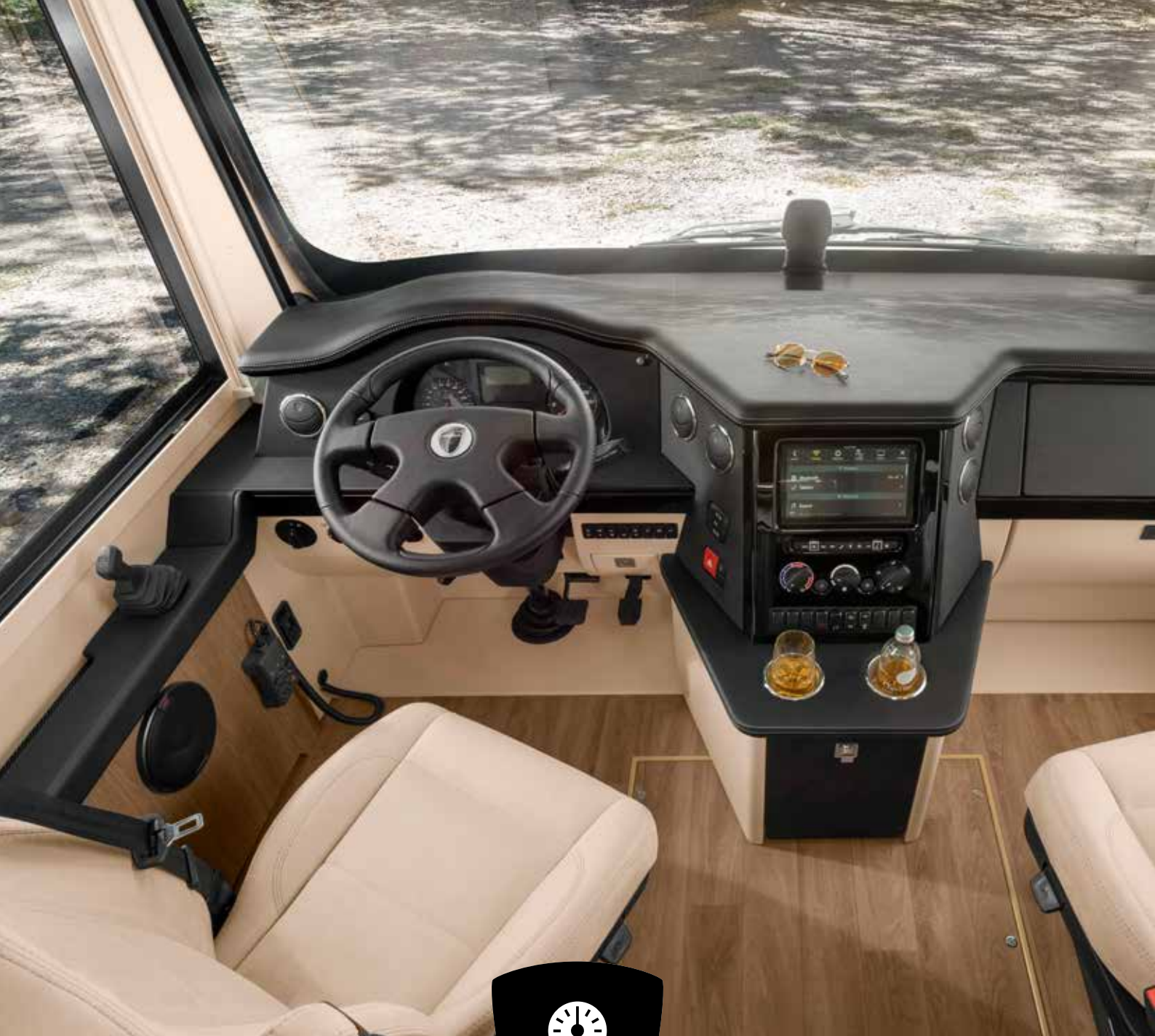

# THE PINNACLE OF COSY

---

**It is never a question between driving or relaxing in a LOFT.** The cockpit is part of the living room. That is why we have also outfitted it with lovingly crafted inlays on the instrument panel and an ambiance that immediately makes you feel at home. The large refrigerated compartment provides plenty of room, so there is no need to worry about refreshments on the way. The large adjustable navigation system (optional) helps you find the best route every time.



IVECO Eurocargo



IVECO Daily



- ✚️ Premium cockpit with leather covering
- ✚️ Dashboard with ambient lighting
- ✚️ Two cupholders, integrated fridge
- ✚️ Driver's cab seats, with swivel base and safety belt system
- ✚️ Luxury driver's cab seats (optional), air suspended, with lumbar support and seat heating
- ✚️ Bus-style outside mirrors
- ✚️ Optimal noise insulation of engine compartment





# FEELING AT HOME

---

**It can't be sunny every day.** Fortunately. Otherwise you would never see how wonderful it is to relax in your LOFT when the weather turns sour. Snuggling into the cushions under the soft ambient light and enjoying a drink while feeling right at home—now that is something special. And not just when it is pouring outside.



LOFT . LOFT LINER



- + Wonderfully comfortable seat cushions
- + Drawers with plenty of space
- + Indirect ambient lighting
- + Plenty of room to move
- + Optionally available with bar seating group





## GIVING IT A LITTLE GAS WITH A LOT OF SOUL

---

**Charting a course is fun.** And not just when you are behind the wheel. The kitchen of the MORELO LOFT lets you start really cooking with gas to showcase your culinary ability. The three-burner gas hob handles several-course meals with ease. From burner to freezer, the fully equipped kitchen in the LOFT has everything on board to take on any culinary challenge.



LOFT . LOFT LINER

- + Three-burner hob
- + Double sink
- + Spice rack
- + Full-length drawers
- + Pull-out rubbish bin
- + Deep overhead cupboards







# EVERYTHING FOR YOUR WELL-BEING

---

**The comforts of home at one of the most beautiful locations while travelling:** The bathroom of your MORELO LOFT. Everything here is for the benefit of your body and mind: The large shower with a real glass door, the ambient light, the mirrored cupboard, the modern wash basin. And, of course, plenty of room. Starting the day refreshed and ending the day in relaxation—that is a small luxury for travellers.



- + Shower with real glass door
- + Shower walls in standalone design
- + Ceramic flush toilet (optional)
- + Large mirrored cupboard
- + Easy-to-clean wash basin





# COMFORTABLE SLEEP TO THE POWER OF THREE

---

**Going to sleep in the bed you have made** means nothing less than first class when it comes to sleeping comfort in the MORELO LOFT. With four different options: A queen bed, front-to-back bed or a French bed. You have the choice. We have taken every step to ensure you have a restful night's sleep in your MORELO LOFT. The sweet dreams are up to you.



### QUEEN BED

The queen bed is accessible from both sides and provides enough room for two additional wardrobes.

Convenient size: **approx. 163 x 200 cm**

### FRENCH BED

Ideal for everyone who wants to be close to their partner at night and delights in having an additional wardrobe.

French-style bed dimension **approx. 158 x 195 cm**

### FRONT-TO-BACK BED

The front-to-back bed maximises your available space and is available as a double bed or two separate beds.

Premium size: **Two times approx. 106 x 200 cm**





## NO ROOM FOR COMPROMISES

---

**Stowage without blockage.** The LOFT does not know the meaning of "tight spaces". It offers more than enough room for luggage both big and small. Souvenirs on the way back also pose no problem at all. In addition to an ample number of drawers and shelves, there is easily room in the rear area for scooters or bikes for mobility at your destination. The heated double floor provides additional stowage space.

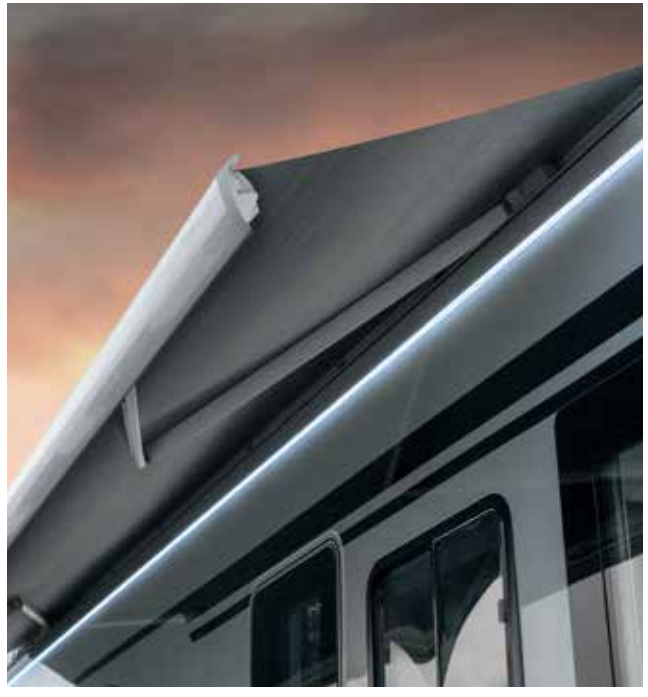

- + Large rear garage, accessible on both sides
- + Plenty of space for luggage
- + All storage spaces are heated
- + Readily accessible storage spaces











# MORELO PALACE





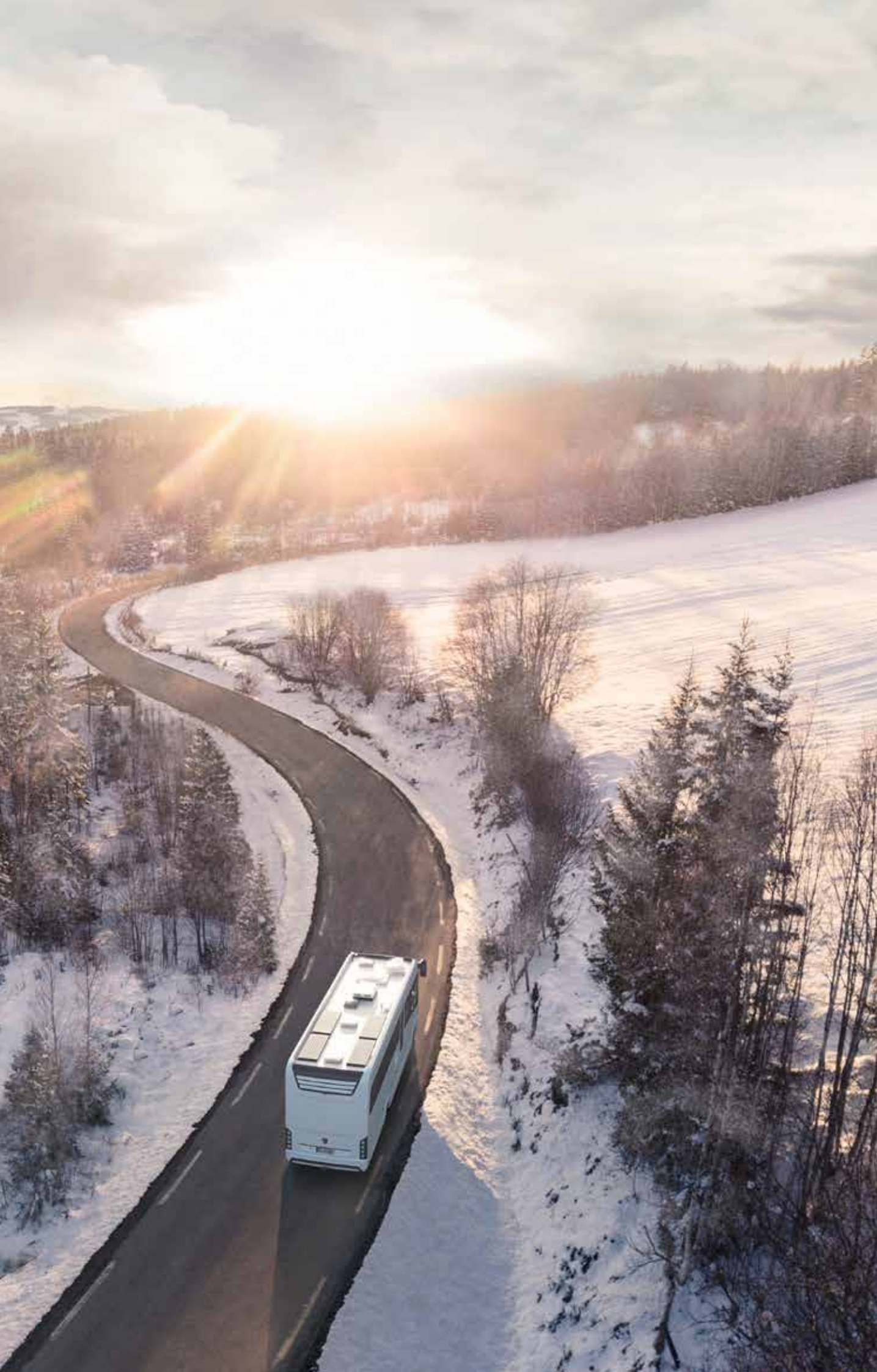





# NEXT LEVEL TRAVEL COMFORT

---

**How do you make First Class even better?** By taking the best and making it even better. The MORELO PALACE fascinates with a particularly striking, modern and dynamic design. The clean lines give your travels an elegant touch. Thanks to the extra wide Wide Axle (optional), you have a whole new driving experience. And so you travel in even more comfort to the most beautiful places in the world.

**At MORELO, not only the appearance counts, but also the inner values.** That's why you find real EMPIRE LINER genes in our MORELO PALACE. And in terms of safety, the PALACE also shifts up a gear. After all, what could be better than being able to fully rely on a vehicle? Probably only the first-class "WELCOME HOME" feeling.

- ✚ Elegant, unmistakable design
- ✚ High quality roof profile
- ✚ Ergonomic rear spoiler
- ✚ Typical rear lighting
- ✚ Underride protection



PALACE

**TECHNICAL SPECIFICATIONS (excerpt)**  
 Chassis: IVECO Daily 70 C 18  
 Emission class: EURO VI e  
 Engine: 3.0 l  
 Power: 132 kW / 180 HP  
 Gross vehicle weight rating: 7.490 kg

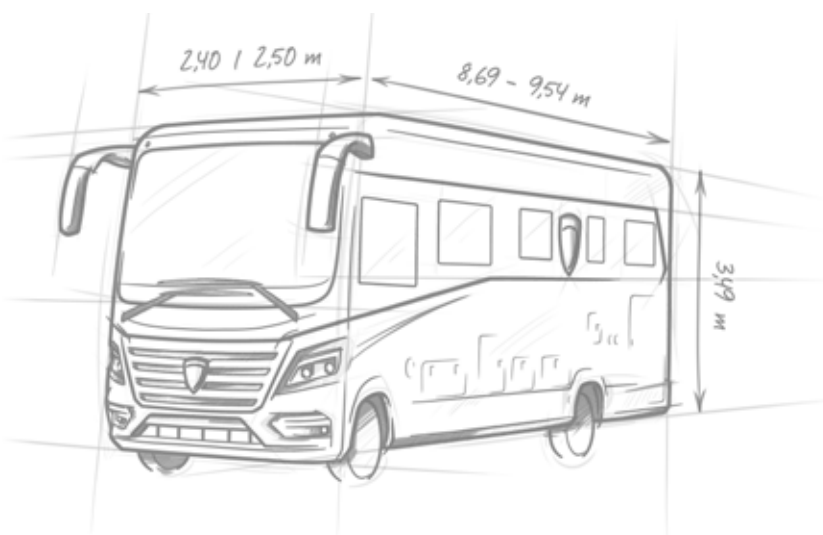





# FUNCTIONAL AND PERFECTLY FORMED

---

**The MORELO PALACE.** With the typical MORELO rear end it's a real eye-catcher. Thanks to the ergonomic rear spoiler you also get a more efficient driving experience with reduced dirt circulation. You are looking good even after your trip.



PALACE



- ✚ Extra wide entrance door
- ✚ Code lock and remote control
- ✚ Retractable, wide entry steps
- ✚ Striking front design
- ✚ Flush cockpit side windows
- ✚ Awning integrated in the roof profile
- ✚ Panoramic outside mirrors



# MORELO PALACE LINER







PALACE LINER





# IMPRESSIVE IN EVERY WAY

---

**The MORELO PALACE LINER simply has more to offer.** And not just thanks to its accommodating size. The elegant lines and striking design make the PALACE LINER a real eye-catcher. The vehicle not only looks great, but feels it too. Whether you are driving over rough terrain or relaxing in the cosy living space – with the PALACE LINER you always travel first class.

**No half measures.** Are safety, functionality and attractive design important to you? Good, because the PALACE LINER offers all three! A powerful diesel engine with rear-wheel drive, a generous 360 litre fresh water tank, smart underride guards and the typical striking details... The MORELO PALACE LINER combines everything you expect from a First Class Motorhome and more.

- ✚ Stylish LED lighting
- ✚ High load capacity
- ✚ Extra-large supply tanks
- ✚ Sophisticated air suspension
- ✚ High safety level thanks to underride guard



**TECHNICAL SPECIFICATIONS (excerpt)**  
 Chassis: IVECO Eurocargo 100 E 25 | 120 E 28  
 Engine: 6.7 l  
 Power: 185 kW / 252 HP | 207 kW / 281 HP  
 Chassis: Mercedes-Benz Atego 924 L | 1230 L  
 Engine: 7.7 l  
 Power: 175 kW / 238 HP / 220 kW | 299 HP  
 Emission class: EURO VI e  
 Gross vehicle weight rating:  
 10,000 kg, 10,500 kg | 11,990 kg

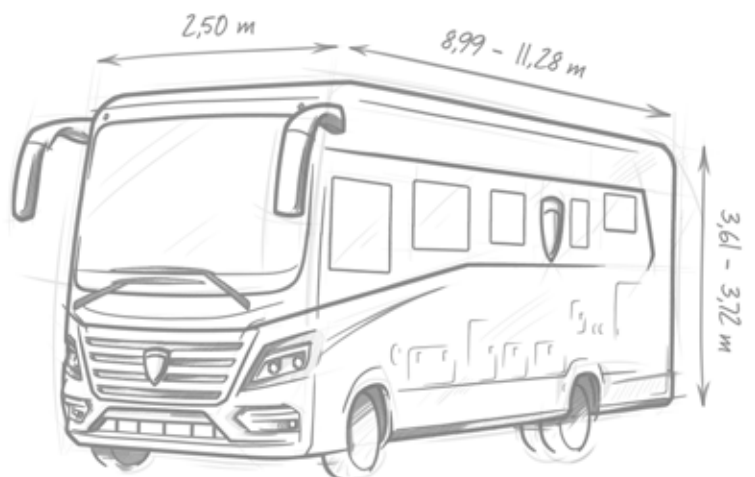





# READY FOR ANYTHING

---

**The MORELO PALACE LINER has an answer to every question.** Most of them at the push of a button. Just one touch and the electronic entrance steps unfold to make entering the vehicle child's play. The optional awning integrated into the roof profile extends in seconds to provide shade or even expand your living space. And if you ask us, every change just makes the PALACE LINER look even better.





- + Modern exterior design
- + Electric roof awning (optional)
- + Extra-wide entrance door
- + Coded entry and remote control
- + Sturdy entrance stairs
- + LCD operating panel
- + Automatic jack system (optional)
- + Electric garage door or rear door





# FIRST CLASS VIEWS

---

**Enjoy the view.** Thanks to the narrow A-columns and the panoramic windscreen. Arriving at the destination, the intelligent darkening system on the front and side windows ensures privacy. You may lean back undisturbed.





Mercedes-Benz Atego



IVECO Daily

- + Premium cockpit**
- + Ergonomic seats**
- + Optimally placed control elements**
- + Removable steering wheel (optional on IVECO Eurocargo)**
- + Glove compartment and map pocket**
- + Cooling compartment**
- + Completely flat cab side windows made of insulating glass with divisible blackout blind and flyscreen**





# EVERYTHING HAS ITS PLACE

---

**Inside as well as outside.** The MORELO PALACE is characterized by functionality. Extra deep wall units and drawers underneath the seats leave nothing to be desired in terms of storage space. The clear lines, atmospheric lighting and a new color concept create a homely yet elegant ambience. No matter where you are right now.



- + Spacious entrance area
- + Light-flooded living space
- + Largest living space in its class
- + Elegant, clear lines
- + Cleverly placed sockets
- + Voluminous storage spaces
- + Drawers underneath the seats
- + Unique look
- + Convincing haptics





# MORE ROOM FOR LIFE

---

**The expansive living space is unique in its class.** You can unwind completely. The extra wide entrance door of the MORELO PALACE offers an even more comfortable entry. Take the first step in a first-class living experience.



PALACE . PALACE LINER







# FOR EACH TASTE

---

**Feast for the eyes.** But you will not get enough of it at the MORELO PALACE. In the practical pull-out cabinet you have all the ingredients always at hand. And the generous worktop offers enough space for all cooking utensils. Everyone simply becomes a First Class star chef.



PALACE . PALACE LINER

- + Clever design
- + Practical pull-out cabinet
- + 177 l compressor refrigerator
- + Three-burner luxury hob
- + Drawers with soft-close
- + Single lever mixing valve in chrome
- + Pull-out rubbish bins
- + Back-lit window trim





# FEELING GOOD AROUND THE CLOCK

---

**Fresh during the day and relaxed at night.** That is everything that the bathroom in the PALACE offers. But that is also what counts. This is everything you need to feel comfortable in your bathroom and energise for a day full of new experiences.

**What could you improve about the perfect bathroom?**

Nothing really. But you can build it in different variants so that people are guaranteed to find the one that fits them personally. Regardless of which bathroom variant you choose, every one has plenty of room to move.

- + Shower cubicle made of real glass
- + Back-lit mirrors
- + Separate toilet room (optional)
- + Hand towel dryer and heater



- + Extendable towel rails
- + Wardrobe with LED lighting
- + Single lever mixing valve in chrome with pullout
- + Spacious drawers
- + Wall cladding in noble stone look





# TRAVEL TO THE PALACE OF DREAMS

---

**Paradise for sleeping in.** The cozy ambience of the bedroom in the MORELO PALACE invites you to dream. Maybe even from your next destination? And the multi-zone cold foam mattresses or the EvoPore mattresses with water gel top layer (optional) ensure a restful sleep in seventh heaven.



PALACE . PALACE LINER







# COMFORTABLE SLEEP IN ANY POSITION

---

**Some people need Arabian Nights to fall asleep.** On the other hand, in a MORELO PALACE, with its fantastically comfortable beds, it is almost impossible not to fall into a pleasant sleep. Queen bed, front-to-back or French bed, you have the choice of how you want to spend the night. First-class sleeping comfort—classic MORELO as you expect.



PALACE . PALACE LINER





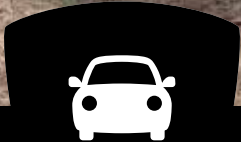

# TRULY EVERYTHING CAN COME ALONG

---

**The MORELO PALACE leaves nothing to be desired.** Especially when it comes to stowage space. After all, you would not want to leave any of your most treasured belongings behind. A compact car for on-site mobility is just as important as souvenirs for your home during the trip back. And then you still need to fit this...and that and this...and you can squeeze a few more items too. Nice that there is the MORELO PALACE.





- + Car garage with cable winch
- + For car or two-wheel depending on the layout
- + Rigging systems
- + Excellent accessibility
- + Additional stowage space in the double floor









**PALACE LINER**



# MORELO EMPIRE LINER

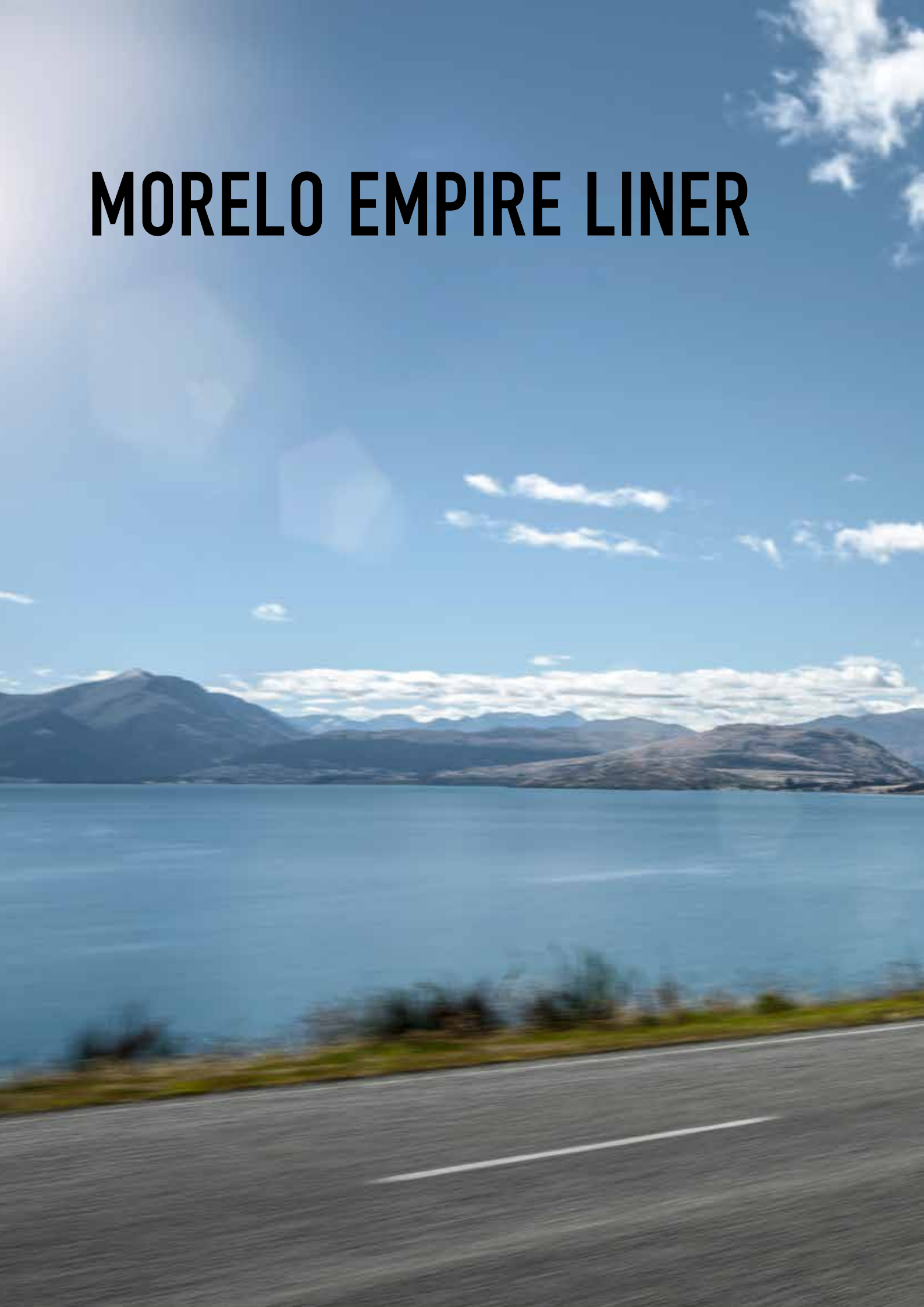



EMPIRE LINER





# HOME IS HOME

---

**Exclusivity, style, comfort.** All this and more awaits you in a luxury motorhome like the MORELO EMPIRE LINER. But let's not be modest. One of our best first-class offers more than just comfort and convenience. The MORELO EMPIRE LINER provides something even more valuable: The feeling of being at home.

**Actually, we are not friends of superlatives.** Nevertheless, we have built one: The MORELO EMPIRE LINER. A top-of-the-range motorhome that offers its passengers every imaginable comfort and looks breathtakingly beautiful. Incidentally, this is also the opinion of the »German Design Council«, which is why the MORELO EMPIRE LINER has been awarded the German Design Award 2018. And we are a bit proud of that.

- Front and rear walls with fibreglass compound sandwich design
- Specially reinforced side walls and roof (52 mm instead of 42 mm)
- Front and rear axle air suspension with "lifting and lowering" function
- Storage space flaps, elegantly integrated into the side walls, opening at the touch of a button
- Twin reversing camera with shutter



**TECHNICAL SPECIFICATIONS (excerpt)**  
 Chassis: Mercedes-Benz Atego 1230 L | 1530 L  
 Engine: 7.7 l | 10.7 l  
 Power: 220 kW / 299 HP  
 Chassis: Mercedes-Benz Actros 1840 L | 1846 L  
 Engine: 10.7 l  
 Power: 290 kW / 394 HP | 335 kW / 455 HP  
 Emission class: EURO VI d  
 Gross vehicle weight rating:  
 11.900 kg, 15.000 kg | 18.000 kg

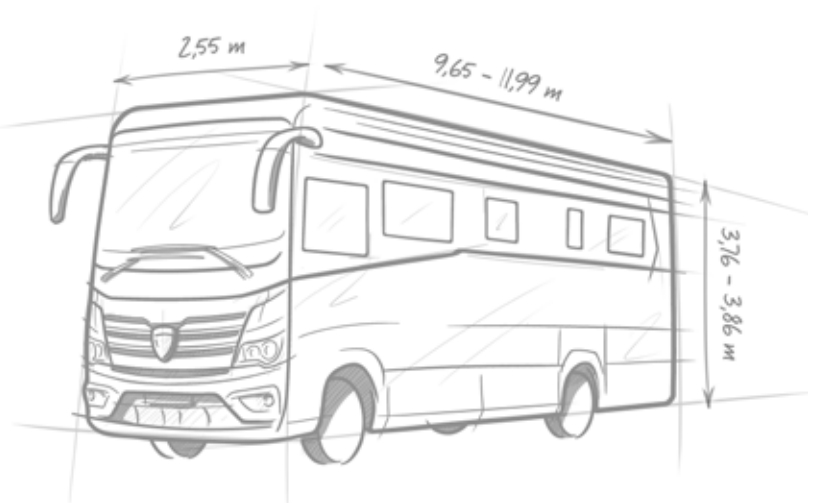





# PERFECT DESIGN INCLUDING ON THE GO

---

**The opportunity to make a first impression never comes again.** The MORELO EMPIRE LINER needs no second chances; it draws you in at first glance. It features a sporty front-end, elegant exterior design, refined contours and smooth side walls from front to back. Wanderlust in its most beautiful form. And the aspects you cannot see can be felt all the more: The extremely thick 52 mm walls that provide outstanding room climate at any outside temperature.





- + Perfect design
- + Double-glazed, real glass windows
- + Heated double floor (approx. 480 mm)
- + Garage door with electric unlock function
- + Innovative GRP module for optimum insulation
- + Optimised sound insulation in engine bay
- + 120 l gas tank





# THE CONTROL CENTRE FOR LIMITLESS WANDERLUST

---

**Climb aboard and immediately feel at home.** Everything is right where you expect. Perfect functionality with the comforts of living that go above and beyond make the cockpit of the MORELO EMPIRE a true wonder. The raised seating position provides an overview and panoramic view of the road and the landscape. Simply start it up and the journey becomes your destination.



Mercedes-Benz Actros



Mercedes-Benz Atego

- ✚ Ergonomic driving position
- ✚ Luxury driver's cab seats, with air suspension and swivel base, lumbar support and integrated safety belt system
- ✚ Bus-style outside mirrors (including wide-angle and front mirror)
- ✚ Electrically operated side windows
- ✚ Navigation system
- ✚ Air-conditioned driver's cab





# MOBILE BUT ALWAYS AT HOME

---

## **Why skip out on something that is an intrinsic part of your life?**

Such as refined convenience, exclusive ambiance in your living room, stylish furniture, seat cushions with unmatched comfort, top-end equipment down to the details and vivid lighting. You do not have to leave any of this behind in your MORELO EMPIRE. Quite the contrary.



- ✚ Exclusive lighting elements
- ✚ Unique lighting concept
- ✚ Modern design
- ✚ High-quality equipment
- ✚ Hot water to heat the floor
- ✚ Level living room floor



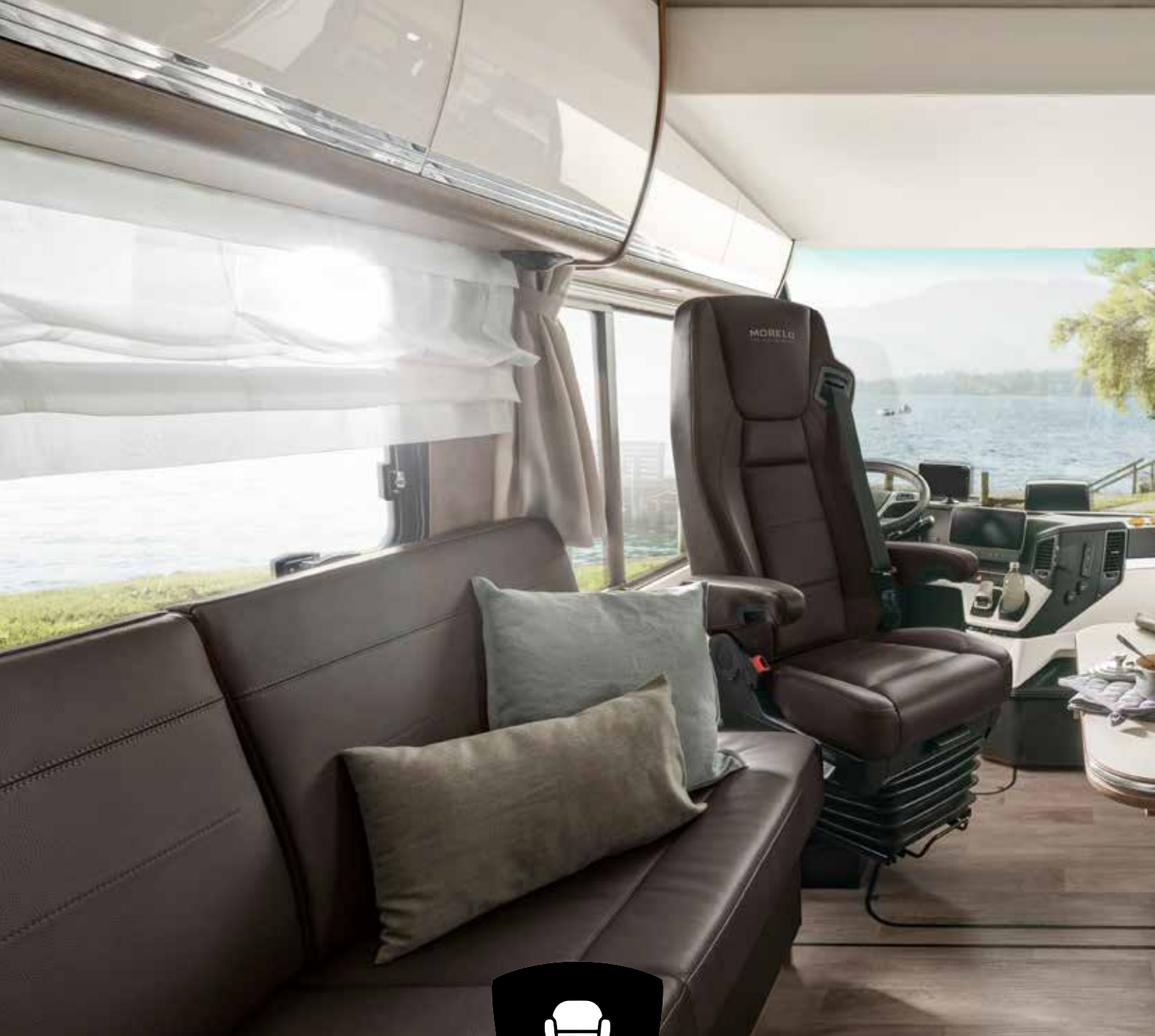

# MUCH MORE THAN JUST FOUR WALLS

---

**Happiness means being comfortable.** Like inside a MORELO EMPIRE. Ample and comfortable seating groups, underfloor heating, air conditioning and an even floor from end to end provide comfort down to the last detail. On the go in a MORELO EMPIRE? Bliss!



EMPIRE LINER



- ✚ Ergonomic seat cushions
- ✚ Multifunctional table
- ✚ Satellite TV system (optional)
- ✚ High-quality workmanship
- ✚ Wall unit fronts with depth effect
- ✚ Elegant panorama roof window





# A LIVING ROOM WITH AN XXL OPTION

---

**True greatness comes from within.** Quite literally in the case of the MORELO EMPIRE LINER with a slide out. At the press of a button, you can conveniently extend the side walls of the slide-out living area to any point up to 45 centimetres, providing a very flexible option for additional room. More room to relax. More room to live.



EMPIRE LINER







# GOOD TASTE KNOWS NO BOUNDS

---

**Gazpacho in Spain or wild salmon in Norway:** The MORELO EMPIRE has an international kitchen and it comes fully furnished to offer all the refinements for putting a region's culinary specialties on your table. Or just simple fare from home. Good taste knows no bounds. Not in a MORELO EMPIRE in any case.



- + Three-flame gas cooker, installed countersunk
- + 196 litre compressor refrigerator with freezer compartment
- + Kitchen worktop made from mineral material with seamlessly integrated wash/waste bowl for optimum hygiene
- + High-quality single-lever mixer tap in chrome
- + Drawers with super-soft closing and cutlery insert
- + Nespresso coffee machine
- + Dishwasher (optional)





# YOUR SPA TO GO

---

**Relaxed comfort in an atmosphere of quiet luxury.** Whether in Lappeenranta in Finland or on the outskirts of Estoril in Portugal, at the beach or in the mountains—the bathroom in the MORELO EMPIRE leaves nothing to be desired with its refined natural stone look, stylish fixtures and lavish amount of space.







# SPARKLING FRESH WANDERLUST

---

**Normally we would never leave you out in the rain.** But this time we are sure you will enjoy it. Enjoy the comfort of showering at home while parked at your favourite travel destinations. Your next spa visit is only ever one door away in a MORELO EMPIRE.



- + Large shower cubicle with real glass
- + Rainfall shower head
- + Stylish wash basin
- + Spacious mirrored cupboard
- + Hand towel dryer and heater
- + Ceramic toilet with soft-close lid







# STARRY SKY INCLUDED

---

**It feels good to be at home.** EvoPore multi-zone mattresses including a comfort sprung base and ergonomic water gel top layer let you enjoy the feeling of sleeping at home every night. And you can look forward to the next amazing day of your trip in your MORELO EMPIRE as you gaze through the panorama roof window at the starry sky twinkling above.



### QUEEN BED

The queen bed is accessible from both sides and provides enough room for two additional wardrobes.

Convenient size: **approx. 163 x 208 cm**

### FRONT-TO-BACK BED

The front-to-back bed maximises your available space and is available as a double bed or two separate beds.

Premium size: **Two times approx. 106 x 208 cm**



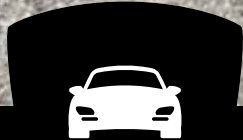
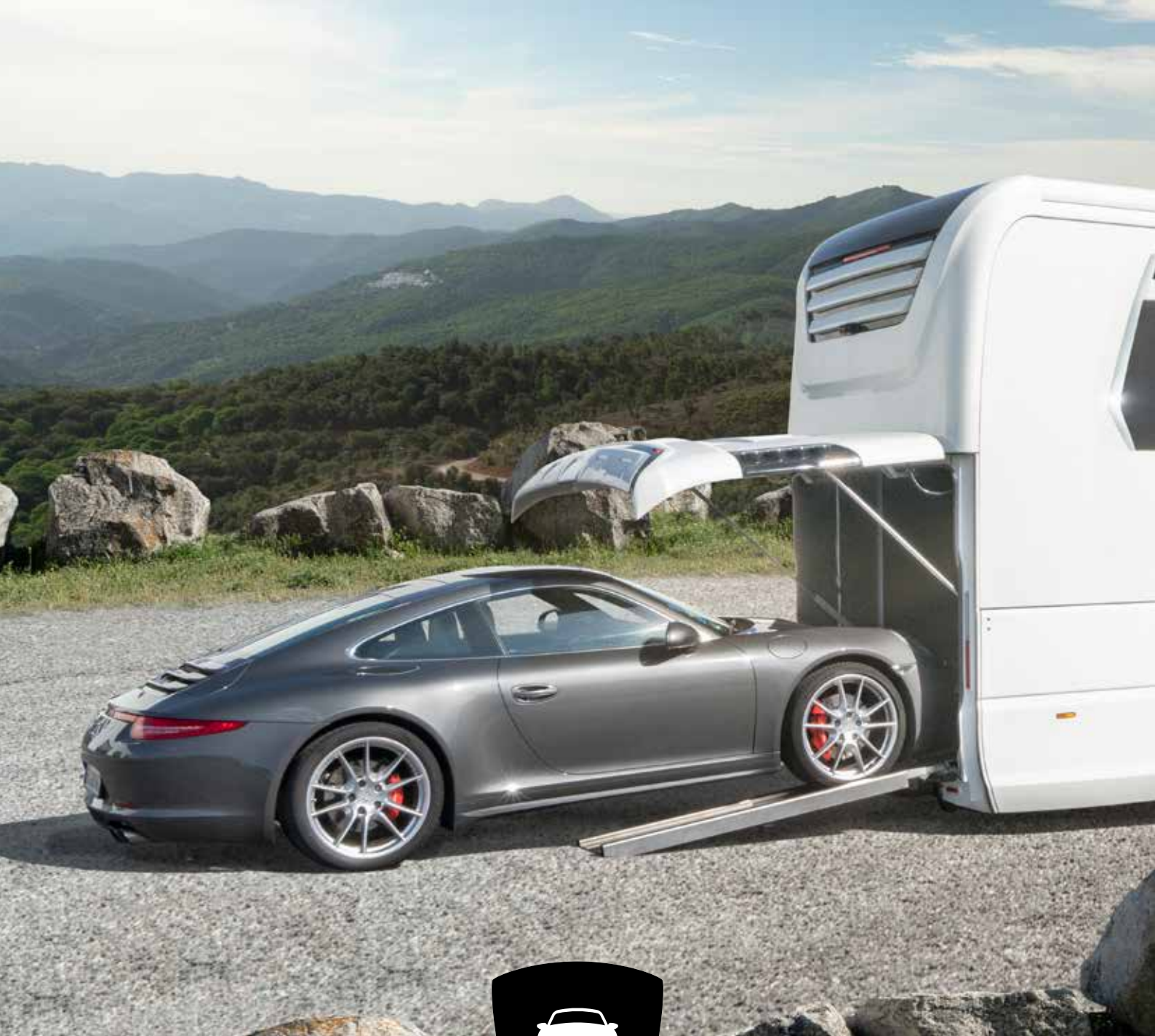

# THE GARAGE WITH THE MOBILITY GUARANTEE

---

**Optionally available with 3,500 watt diesel generator.** This is what the rear garage of the MORELO EMPIRE can offer—but who needs that much water? How about some bicycles, scooters or motorcycles instead? Or maybe something that offers a little more comfort? Also a Smart, Fiat 500, Mini Cooper, Porsche, Mercedes AMG GT or even a Ferrari find space in the MORELO EMPIRE LINER.



EMPIRE LINER



Images and descriptions may contain options that are subject to surcharge.







EMPIRE LINER



# MORELO GRAND EMPIRE







GRAND EMPIRE





# OUR FLAGSHIP

---

**A vehicle without compromise** – the GRAND EMPIRE is the pinnacle of our luxury motorhome range. With the unmistakable MORELO interior and exterior design, it clearly shows what first-class travel really means: experiencing complete freedom without compromise. Is there anything better than travelling to far-flung places, yet waking up at home?

**Welcome home on a whole new level.** From its high-performance chassis to a unique energy concept to the brilliant standard equipment, the GRAND EMPIRE is a statement of self-sufficient luxury that could not be any more impressive. So what are you waiting for? Take the GRAND EMPIRE on the journey of your life and enjoy unlimited freedom.

- ✦ Mercedes-Benz Actros 1853 chassis
- ✦ Enhanced MORELO design
- ✦ Cutting-edge vehicle technology
- ✦ 230 volt power supply
- ✦ High level of standard series features
- ✦ Ample capacities
- ✦ 500 l fuel tank



**TECHNICAL SPECIFICATIONS (excerpt)**  
 Chassis: Mercedes-Benz Actros 1853 L  
 Emission class: EURO VI e  
 Engine: 12,8 l  
 Power: 390 kW / 530 HP  
 Gross vehicle weight rating: 18.000 kg

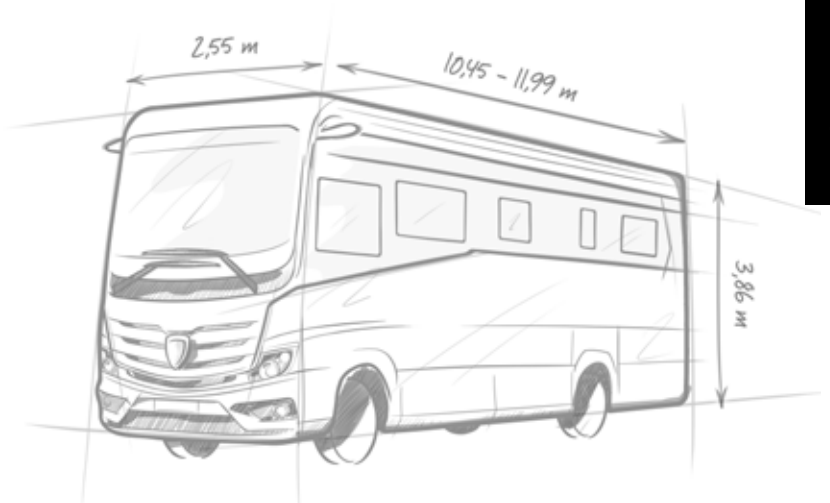

GRAND EMPIRE





# VISION OF A NEW DIMENSION

---

**A MORELO better than anything you have seen before.** If customers desire more luxury, even more space, more performance and more safety, we will find a way to make these wishes a reality. With the GRAND EMPIRE, we have managed to exceed even our wildest expectations.



- + Front and rear axle air suspension
- + Fully automatic hydraulic levelling jacks
- + Light metal rims ALCOA Dura Bright on front and rear axles, 22.5"
- + Stainless steel power box installed under the vehicle to save space
- + "TOP Class" entrance door, extra large
- + Outside applications in real glass, black
- + Illuminated MORELO logo on the vehicle front



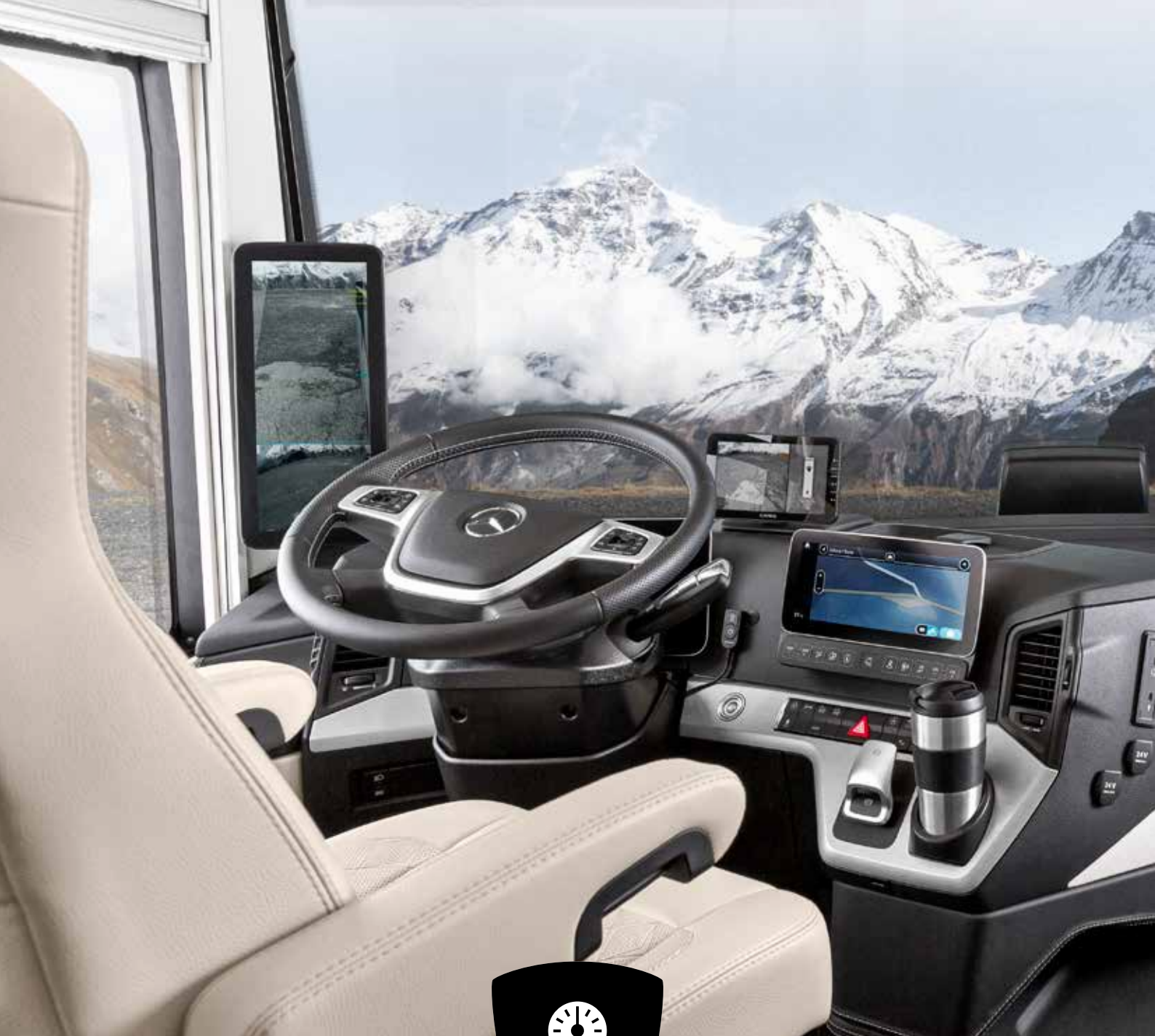

# TAKE A SEAT AND EXPERIENCE SPACE

---

**The journey begins as soon as you take a seat.** High-quality, air-suspended driver's cab seats with lumbar support and adjustable armrests ensure optimum comfort and support an ergonomic seating posture, even on long trips. Heated and ventilated seats help provide the perfect ambient conditions inside, regardless of the temperature outside. This ensures that you reach your destination in the greatest comfort.



- + Driver's cab seats with ROYAL leather upholstery
- + Interactive multimedia cockpit
- + Digital MirrorCam camera system
- + BirdView camera set with 7" monitor
- + Twin reversing camera with shutter
- + Original Mercedes-Benz navigation system
- + Air-conditioned driver's cab
- + Double horn air fanfare in the engine compartment
- + Numerous driver safety systems



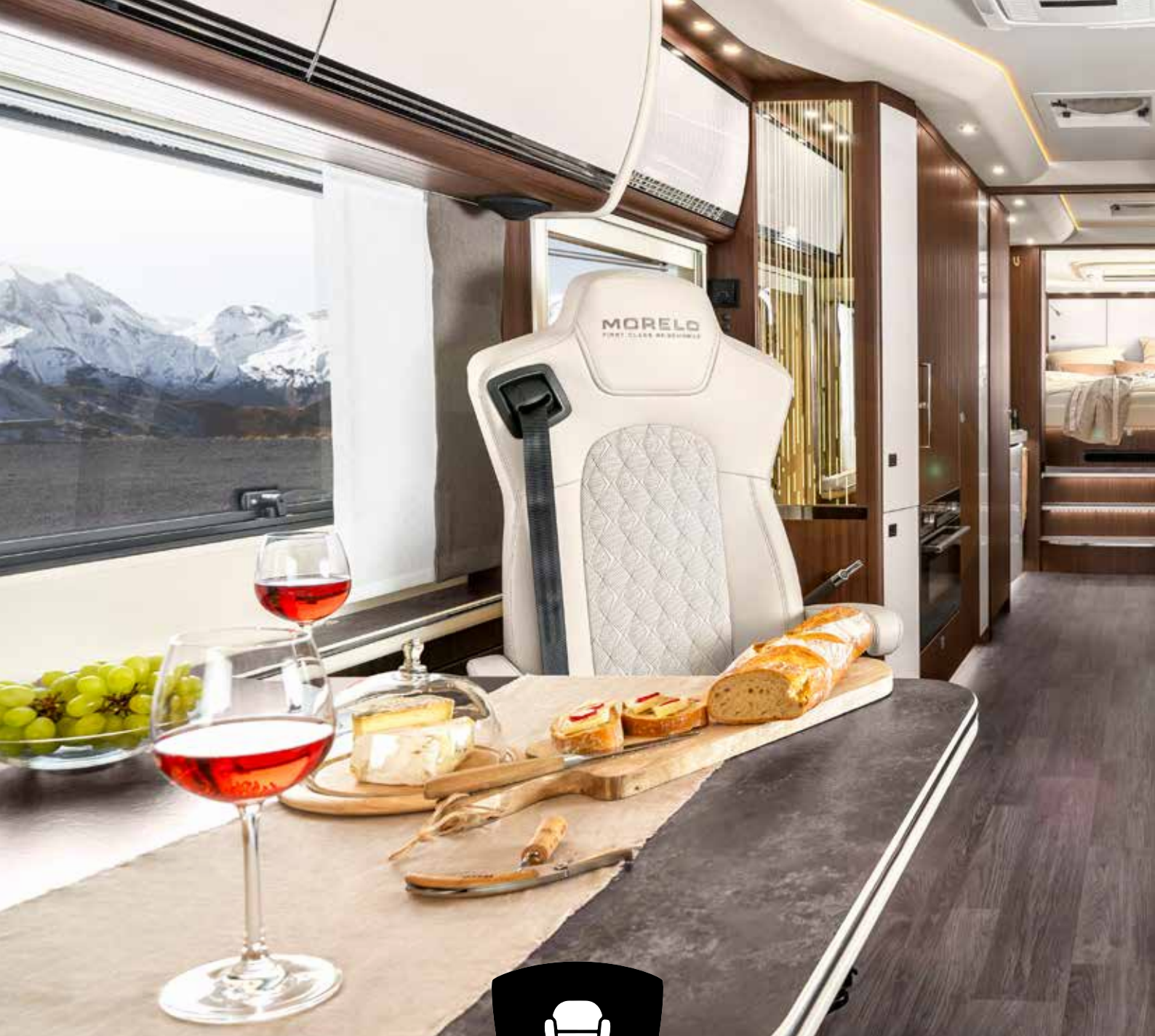

# SILENCE IS A LUXURY. SOUND IS A LUXURY.

---

**What exactly makes the GRAND EMPIRE so appealing?** The answer is endless space. Fantastic sound insulation thanks to reinforced side walls and roof with a thickness of 52 mm. Great acoustics thanks to the dual-zone high-end sound system with 12 loudspeakers. Perfect ambient conditions at the push of a button not just in the driver's cab, but also in the living and sleeping areas. And cosy warm feet on all levels, even when it's -36 °C outside..



- +** Completely gas-free supply thanks to Scheer fuel heating system with 10/17 kW
- +** Seating area with ergonomic ROYAL leather upholstery
- +** Floor heating in the driver's cab, living area, bathroom
- +** Roof air conditioning units in the living/sleeping areas, individually controllable via remote
- +** Two double-glazed panoramic roof windows in the living and sleeping areas
- +** Double-glazed and tinted real glass window in the living area





# TRUE GREATNESS COMES FROM WITHIN

---

**With the slide-out option,** you can extend the generous living space and kitchen in your GRAND EMPIRE by up to 45 cm – without cold bridges and at the touch of a button. Settle into the luxury lounge and enjoy a relaxing massage, also available at the touch of a button. The ergonomic driver's cab seats can be rotated and provide maximum seating comfort – ideal for long journeys.



- +** Slide-out function (depending on the floor plan) to add 45 cm to your living area and kitchen, including extended kitchen worktop
- +** Luxury lounge and driver's cab seats with ROYAL leather upholstery
- +** Driver's cab seats with swivel base, armrest and integrated safety belt system
- +** Luxury lounge with extendable leg support and massage function
- +** Solid table, extendable, with large adjustment range





# THE BEST MEALS ARE MADE AT HOME

**Blanched, flambéed or crispy fried? Roast beef with jacket potatoes, or maybe a crema catalana?**

The GRAND EMPIRE has the perfect ingredients for every taste – from a high-quality built-in compact oven with microwave and grill function to an induction cooker and the 196-litre compressor refrigerator with freezer compartment. All devices come with a powerful 230 V design, to make sure that everything feels just like “HOME”.



- + 196 l compressor refrigerator with freezer compartment
- + Built-in compact oven with microwave and grill function
- + Induction cooker
- + Luxury dishwasher underneath cooker
- + Kitchen worktop made from mineral material with seamlessly integrated wash/waste bowl for optimum hygiene





# YOUR PERSONAL ENERGY SOURCE

---

**Just stop the clock. Just be myself.** Even such elusive wishes as these will come true in a MORELO GRAND EMPIRE. Look forward to a top-class en-suite bathroom. Discover countless amenities and little details for added comfort. Be inspired by a place that brings body, mind and soul into perfect harmony.



GRAND EMPIRE





# THIS RAIN WILL MAKE YOU HAPPY

---

**The large shower made from real glass has a rain shower and a separate handheld shower head** with high-quality multi-functional taps. The wide wash basin in front of the impressive mirror cabinet turns the GRAND EMPIRE bathroom into an oasis of well-being and guarantees the perfect start to every day. A particular highlight is the separate ceramic toilet with extendible showerhead and air extraction.



- + Wash basin with seamlessly integrated sink and push-open valve
- + Shower made from real glass with a rain shower and handheld shower head
- + Ceramic toilet with approx. 280 l solid tank
- + Large wardrobe with LED lighting







# RECHARGING YOUR BATTERIES

---

**Just imagine falling asleep in the most beautiful places and the most comfortable bed on earth.**

Sounds great, doesn't it? It feels even better, thanks to high-quality EvoPore multi-zone mattresses, an ergonomic watergel top layer and a first-class comfort sprung base. Combined, all of these aspects are sure to boost your recovery.



**After all, great discoverers need a good night's sleep.** Wer sich für einen MORELO GRAND EMPIRE entscheidet, der investiert nicht nur in ein Luxus-Reisemobil. Er investiert in Lebensqualität. Einzigartige Erlebnisse. Und in einzigartigen Komfort – auch beim Schlaf. Und das ist klug. Denn im Schlaf regenerieren wir und verarbeiten zugleich die Erlebnisse des Tages. Und davon sollte es, einmal unterwegs mit dem GRAND EMPIRE, ja eine ganze Menge geben ...





# YOUR DESTINATION: FREEDOM

---

**Is there anything better than exploring far-flung bays and fishing villages at your holiday destination from the seat of a quick and agile car?** The MORELO GRAND EMPIRE can also make this wish come true. Depending on the model and floor plan, the rear garage offers enough space for compact and sports cars with a length of up to 4.6 m, ensuring that you remain flexible once you have reached your destination.



- + Rear garage with electric door for cars and sports cars with a length of up to 4.6 m (depending on the floor plan)
- + Electric winch with emergency stop function
- + Rear garage can also be used for bicycles, scooters and motorcycles
- + Clearance (H x W in mm): 1,570 x 2,100







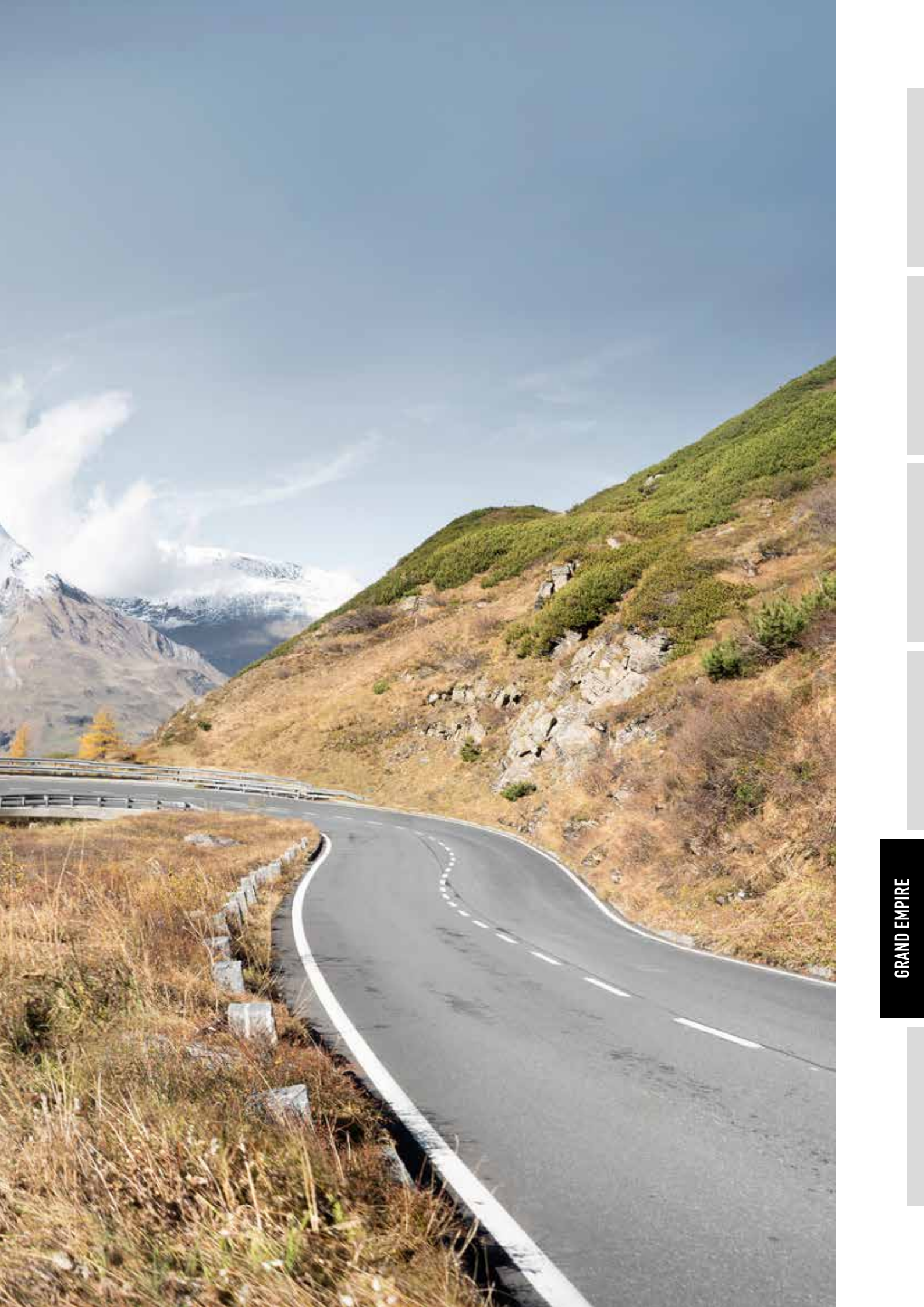





Mercedes-Benz Atego 1530



IVECO Daily 70 C 21

## DRIVING WITH CONFIDENCE

---

**A ride as stable and comfortable as a train.** Just with more mobility and versatility. Experience this for yourself in all MORELO models on IVECO or Mercedes-Benz chassis. Outstanding quality, superior performance and state-of-the-art chassis technology, from the sturdy ladder frame, to front and rear underride guards which prevent cars from submarining under the vehicle in the event of an accident. Your foundation for enjoying travelling for many thousands of miles.



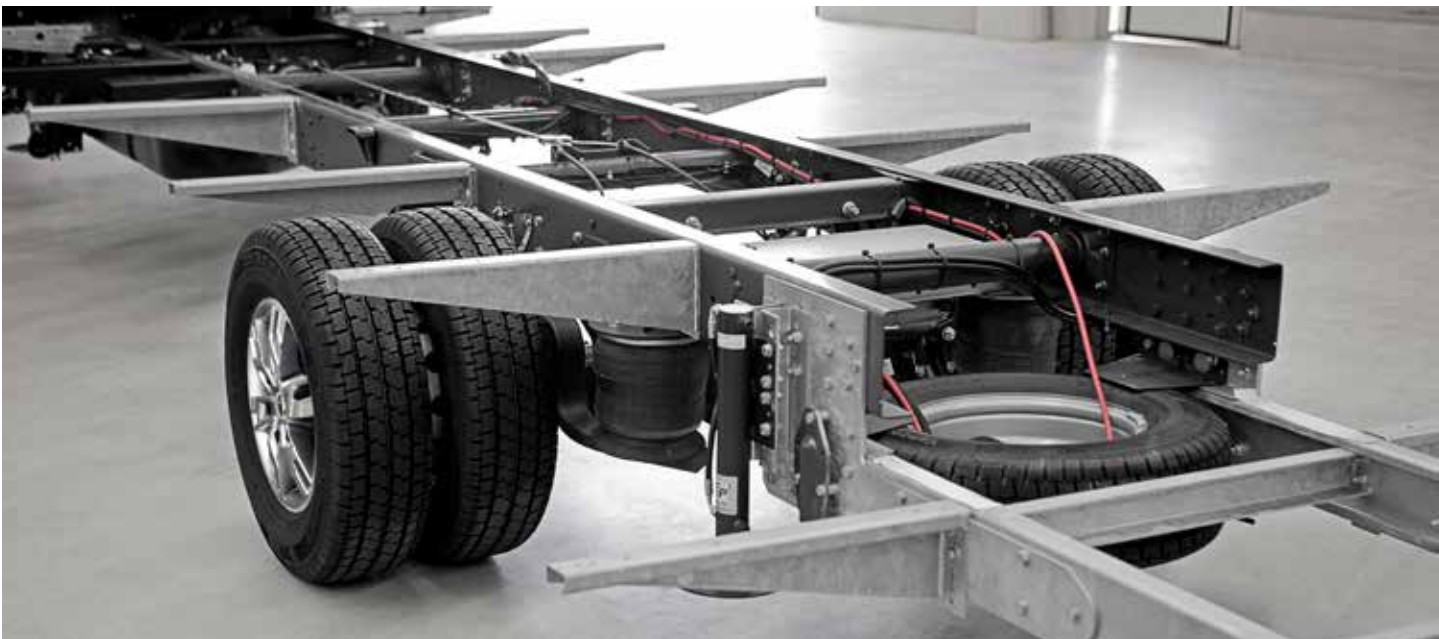

**STABLE LADDER FRAME**

An excellent motorhome needs a solid base, such as our stable, hot-dip galvanised ladder frame.

- + Rear can be lowered, low loading sill
- + Sturdy stabilisers for a stable design
- + High torsional strength

**FRONT MODULE MADE OF GLASS-FIBRE-REINFORCED PLASTIC**

Developed with Fahrzeugbau Meier and already installed in thousands of MORELO motorhomes.

- + Elevated seat position
- + Level living room floor
- + Perfect insulation



EXPERT ADVICE

# THE BEST BUILD ON US



### WHY THE FOUNDATION IS CRUCIAL

Every home needs a base that provides stability and security. Of course, this also applies to your MORELO.

We build chassis that you can rely on. And that is precisely why MORELO relies on us in turn. Because in our job we act according to a simple principle: we work with our expertise and our craft so that a manufacturer like MORELO can fulfil its brand promise of "First Class Reisemobile" and guarantee its customers a first-class driving experience.

More comfort, more independence and of course more safety. That's what our customers rely on. **That is Meier.**

### ZF 8-SPEED CONVERTER GEARBOX (IVECO DAILY)

The absolute best drive comfort The new 8-speed automatic from the gearbox specialist ZF makes this possible.

- + Wear-free start-up
- + Switching gears is barely noticeable
- + Maximum drive comfort

# MEIER

[www.fahrzeugbau-meier.de](http://www.fahrzeugbau-meier.de)

TECHNOLOGY



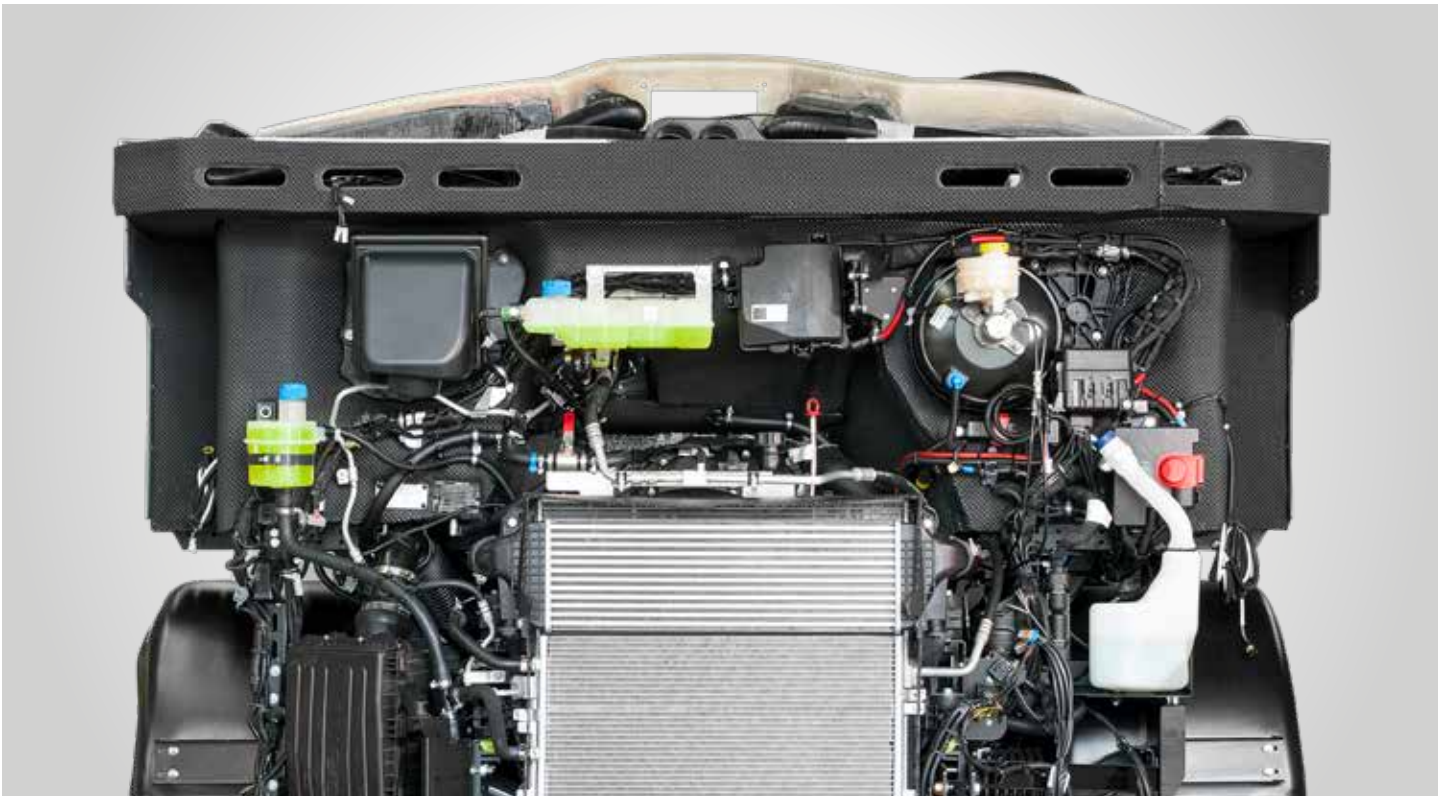

### DOUBLE REVERSING CAMERA

The double reversing camera (optional), with one close-range camera and one long-range camera, makes manoeuvring a breeze.

- + Near the tailgate
- + Perfect visibility behind the vehicle
- + Digital rear-view mirror

### JACK SYSTEM

A jack system (optional) provides maximum convenience and is especially useful for prolonged periods without movement.

- + Effective level compensation
- + No unpleasant wobbling
- + Decreased stress on the tyres

### DUAL COMPRESSED-AIR HORN

An impressive vehicle should also sound impressive, which is why we offer the option to have a dual compressed-air horn installed.



### ALLOY WHEELS

Consider adding light alloy rims if you want to give your MORELO even more elegance.

- + Sporty look
- + Easy to clean
- + Excellent durability

### EXPERT ADVICE

## KEEP GOING, WHATEVER THE TERRAIN



### A PERFECT COMBINATION: DIFFERENTIAL LOCK AND TRACTION+

The Daily HI-MATIC is the only chassis in its class to use rear-wheel drive, which combines the comfort and safety of a mechanical differential lock and Traction+.

The mechanical differential lock ensures you can continue your journey on tricky surfaces by transferring the entire torque to the wheel with grip. Traction+ is deployed as an additional function on routes with different road surfaces and particularly winding roads. In contrast to the mechanical differential lock, this function can also remain active on grippy surfaces.

The combination ensures a safe and relaxed journey at all times.

Your IVECO motorhome experts



[www.iveco.com](http://www.iveco.com)



#### 4-CHANNEL AIR SUSPENSION

Travelling on cloud nine thanks to the air suspension (optional). No other system offers this kind of heavenly driving comfort while providing the true reliability to handle different load conditions.

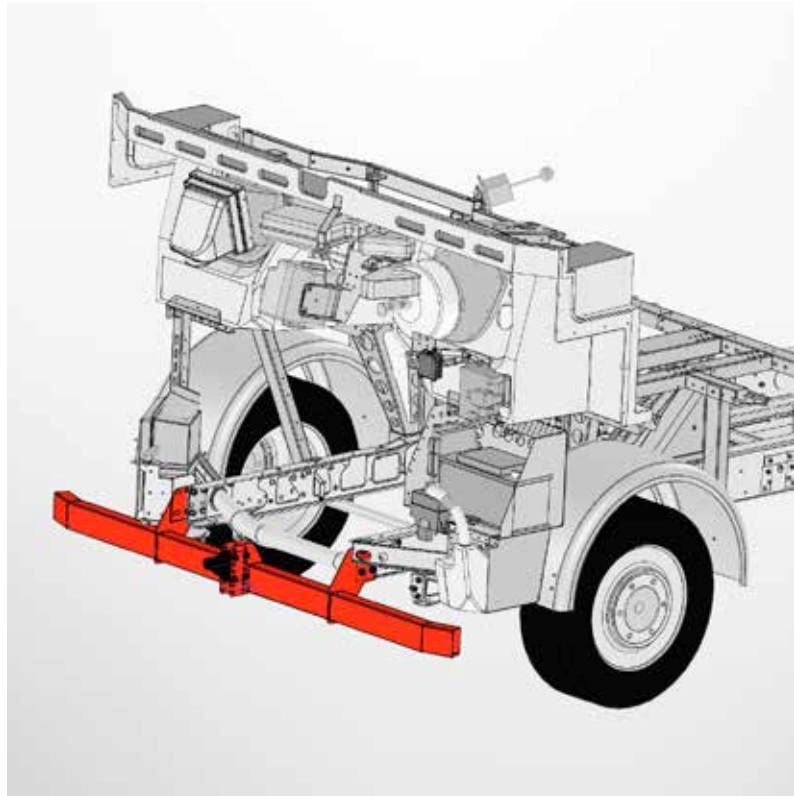

#### VB-AIRSUSPENSION ACTIVEAIR

A smart suspension and damping system that adjusts to road conditions and the load in real time. (optional)

- + Approx. 40% less side tilt
- + Approx. 15% shorter braking distance
- + Approx. 8% less sensitivity to side wind

#### UNDERRIDE GUARDS

The underride guards (depending on model) prevent a car from sliding under the vehicle in the event of a rear-end collision, reducing the potential damage from the accident.

- + Compliance with the latest standards
- + Linked to the chassis frame
- + Reduced damage from accidents



### TELMA RETARDER

The wear-free optional eddy-current retarder handles up to 90 percent of all braking operations. It effectively relieves the strain on the main brakes and minimises wear. Relaxed driving with a solid feeling of additional safety.



### WIDE AXLE

The optional wide axle takes the driving behaviour of the IVECO Daily to another level. The wheels are offset further out, increasing driving stability even further and minimising side tilt to make it even easier to turn and drive around bends.

- + 200 mm wider front axle
- + Larger track stability
- + Dramatic look for the motorhome
- + Better roadholding
- + Reduced side tilt
- + Stabilised in side wind



**PREMIUM WALL DESIGN**

In a MORELO, you're surrounded by the best motorhome possible in motorhome construction. The interior and exterior walls offer stability thanks to their extremely corrosion-resistant aluminium alloy design. The hydrophobic XPS rigid foam provides a sensational insulation value. With the light weight you expect.

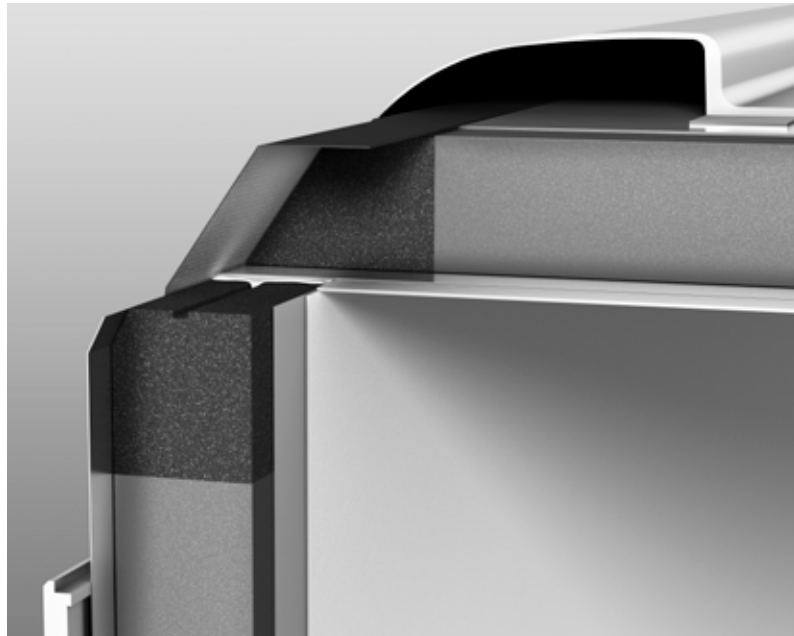
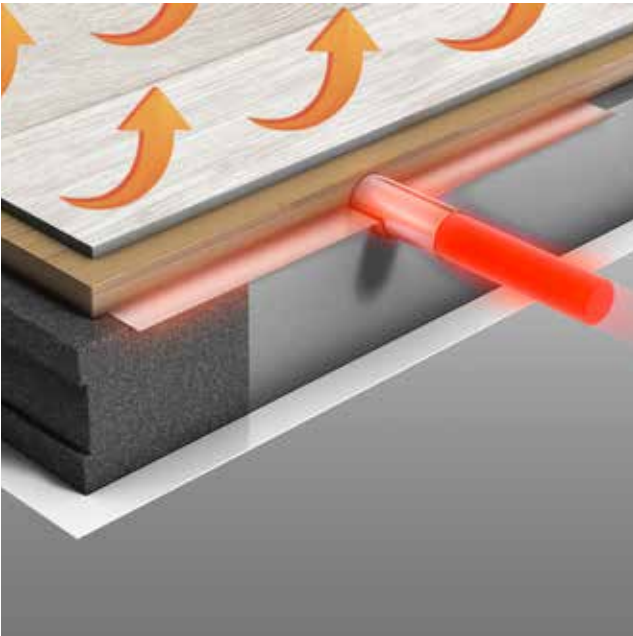
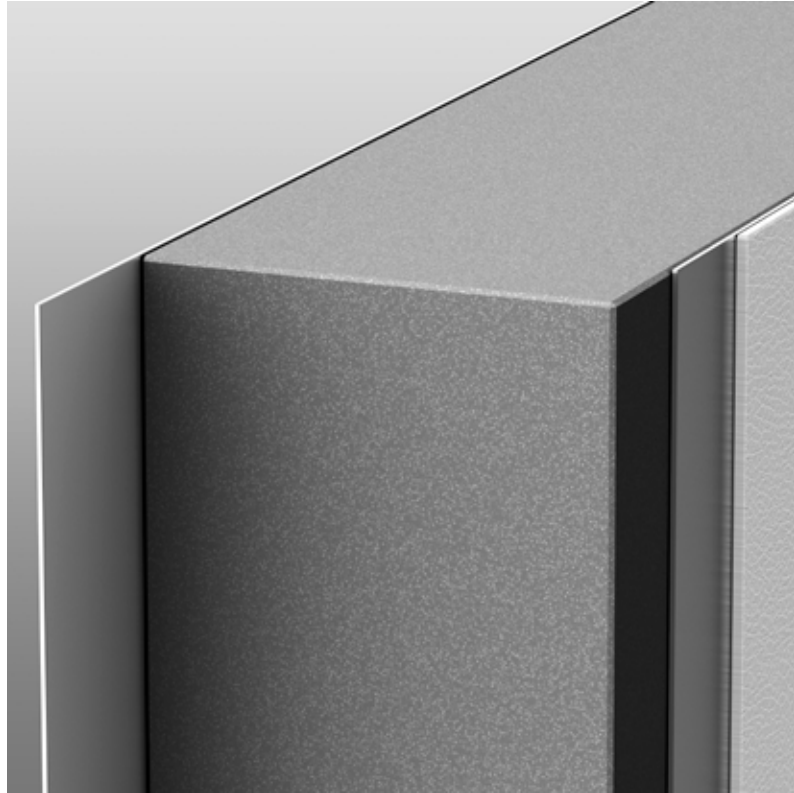
**PREMIUM LIVING ROOM FLOOR**

The high-quality PVC floor with a wood look is easy to clean and completely waterproof.

- Fine wood look
- Waterproof thanks to PVC floor covering
- Easy to clean

**PREMIUM ROOF DESIGN**

We build motorhomes with care, and think about how to guide water through the vehicle to ensure that side walls are not subjected to water damage.

- Lightning protection thanks to an aluminium underbody
- Optimum hail protection
- Adhesion without any thermal bridges

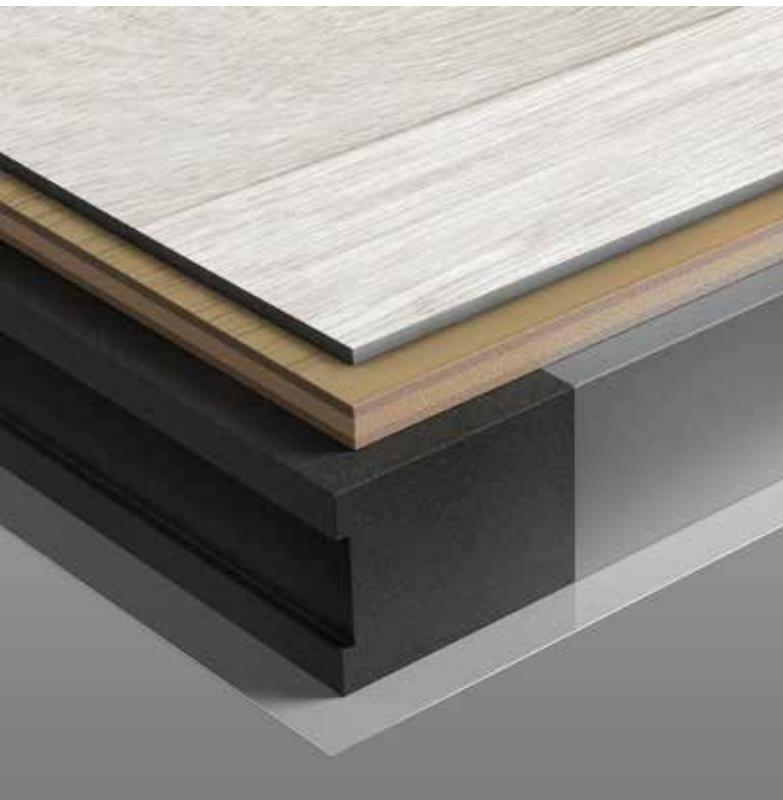
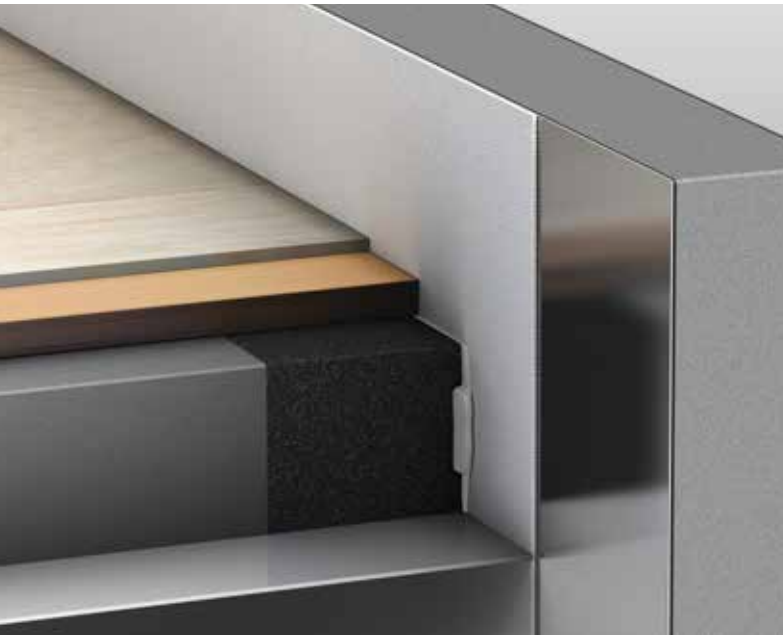

**PREMIUM UNDERBODY**

Thanks to its stable glass-fibre-reinforced plastic underbody, there's absolutely no need to worry about moisture or corrosion.

- + 100% waterproof
- + Partition panels made of ABS plastic
- + Optimum insulation values thanks to XPS foam

Images and descriptions may contain options that are subject to surcharge.

**EXPERT ADVICE**

**PREMIUM QUALITY  
AT ITS CORE!**



**DURABLE AND OPTIMUM INSULATION  
FOR YOUR MOTORHOME**

When it comes to ensuring optimum thermal insulation and durability of your motorhome or caravan, forward-looking manufacturers such as MORELO rely on high-performance insulating materials from **RAVAGO BUILDING SOLUTIONS**.

With their low weight and excellent insulation properties, the **RAVATHERM™ XPS X PLUS RTM** and **RAVATHERM™ XPS X PLUS LB** core layer materials enable high-quality wall structures – for maximum energy efficiency, low fuel consumption and a long service life of your motorhome.

Another benefit of the XPS insulation materials from RAVAGO BUILDING SOLUTIONS is their closed cellular structure, which helps prevent the formation of mould to ensure that you can lean back and enjoy the comfort of your mobile home.



[www.ravagobuildingsolutions.com/industry](http://www.ravagobuildingsolutions.com/industry)





**LUXURY FRONT END**

Whether in scorching heat or icy cold temperatures, we've got you covered. A large grille prevents the engine from overheating, while the exhaust heat is used to heat the living space via a heat exchanger.



**BUS-STYLE EXTERIOR MIRRORS**

There's no need to worry about blind spots. Extra-large exterior mirrors give you a clear rear view. (Optionally available on HOME)

- + Integrated wide-angle mirrors
- + Large field of vision
- + Heated

**COCKPIT SIDE WINDOWS**

The flush side window prevents dirt and water streaks and can be set at any position. (Not available on HOME model)

- + Reduced wind noise
- + No thermal bridges
- + Insulation double glazing



### ENGINE BONNET

Easy accessibility thanks to parallel opening and pneumatic lifters. The large radiator grille offers a dynamic, powerful look while providing protection from overheating.



### SLIDE-OUT

Need more space? The Slide-out option for LINER models increases the width of living space and kitchen by up to 45 cm.

- + No thermal bridges
- + Infinitely variable extension
- + Manual emergency operation possible

### ACCESSIBILITY WITH ATTENTION TO DETAIL

All the important items can be accessed quickly thanks to smart use of space in the rear and double floor as well as optimal access.

- + Optimal use of space
- + Unimpeded access
- + All important items can be accessed quickly





**REAL GLASS WINDOWS**

(Standard on EMPIRE LINER models, optional from PALACE models up)  
 The tinted, hinged windows feature several opening levels and guarantee optimal ventilation. They offer perfect integration into the side wall, with high-quality insulated glazing and a locking mechanism with solid aluminium latches. They are also easy to clean and resistant to scratches.



MORELO EMPIRE LINER

**STORAGE SPACE PANELS WITH BUS LUGGAGE COMPARTMENT DOOR DESIGN** (From EMPIRE LINER Class)

Featuring a newly developed division of the underfloor and double floor areas. This means no unnecessary stooping if you do not need to get to the chassis. The doors are frameless, fully insulated and free of thermal bridges, featuring an internal electric lock and high-tech hinges developed specifically for MORELO.

- + Convenient accessibility, large opening angle
- + Stylish integration into the side wall
- + Opens at the press of a button
- + Special internal hinges
- + Special opening mechanism
- + Opening function using gas springs



### REAL GLASS PANELLING

(Standard on EMPIRE LINER models, optional from PALACE models up)

The real glass panelling creates an accented surface that incorporates the windows seamlessly. Innovative design for a first-class motorhome.



MORELO EMPIRE LINER

### SIDE SKIRTS

Perfectly integrated into the side with access to the chassis, fuel tanks, batteries, waste water connections and technology. (model-specific)

- + Covers built-in central locking system
- + Large opening angle
- + Stylish design

### ENTRY PORTAL

Electric unfolding entrance stairs with 2 steps (3 steps on 12 t models and above). The steps are extremely stable and offer secure footing.

- + Three steps (12 t or larger)
- + Extra wide and extremely stable
- + Electric fold-out function





### WINDSCREEN WIPER SYSTEM

The extra large wiper field ensures you always have the visibility you need. Thanks to the sprayers integrated into the wiper mechanical system, the premium wiper blades guarantee excellent road visibility results.



### QUALITY MADE IN GERMANY

With great attention to detail and extensive expertise, we build first-class motorhomes for every demand in Schlüsselfeld near Bamberg, Germany.

- + Continuous field testing
- + In-house R&D
- + Ongoing development

### AWNING INCORPORATED INTO ROOF CONTOUR

The optional awning is seamlessly incorporated into the roof contour and can be installed on both sides of the vehicle as a single or even a double awning.

- + No wind noise
- + Electric extension function, rugged 220 V motor
- + Awning with LED lighting



### LIGHTING CONCEPT

Our lighting concept consists of LED daytime running lights and state-of-the-art headlamps and provides good visibility at all times.

- + LED daytime running lights
- + Fog lights with cornering light
- + Elegant design

### REAR SPOILER

It reduces turbulence behind the vehicle, which also reduces dirt on the back end.

- + Protects the roof connection
- + Third integrated brake lamp
- + Sporty look





**EXTRA-WIDE ENTRANCE DOOR**

A standard feature on MORELO vehicles: Lots of space to enter and exit the vehicle. The door closes quietly and securely.

- + With remote control
- + Integrated flyscreen
- + Window with blackout blind

**"TOP-CLASS" ENTRANCE DOOR**

The glass-fibre-reinforced plastic door with integrated stainless steel strips prevents break-ins to ensure that you're completely safe.

- + High level of safety from break-ins
- + Electronic door lock with coded entry
- + Optional on LOFT models, standard on PALACE models and above



**A SPARKLING IDEA**  
 A ceramic coating ensures your vehicle will always shine. And the best thing about it is that cleaning the exterior of your vehicle is a breeze.



**CERAMIC COATING FOR A FIRST-CLASS APPEARANCE**

Our optional high-performance ceramic coating optimally protects side walls as well as the front and rear against damaging environmental impacts, such as road salt, brake dust or UV radiation. It is similar to a hard glass layer that is applied to the paint.

- + Significantly reduced maintenance effort
- + High-quality products
- + Increased UV protection
- + Self-cleaning thanks to pearling effect
- + Protection against micro scratches
- + Value retention of your MORELO motorhome





**AMAZING STORAGE CAPABILITIES**

Not having to go without something while on the go: that is real luxury. This is why vast storage space has always been a standard feature at MORELO.

- + Low boot sill
- + Easy accessibility
- + Safe-closing panels

**ELECTRIC BICYCLE LIFT**

For car garages, we offer a clever storage option for bicycles, consisting of a lift platform above the car that is extendible for easy access.

- + Bicycle lift available as from model 110
- + Lift platform with 2 x 230 V sockets
- + Four lifting belts with reliable motors

**A NEW SENSE OF INDEPENDENCE**

Why should your mobility stop at the campsite? Wouldn't it be better if it was just the starting point? The sky is the limit when you take your own car with you on your travels. And we promise that you only have to try it once to know you never want to miss out on it ever again.



**ILLUMINATED FRONT LOGO**

Let your MORELO shine even brighter! An illuminated logo in the grille clearly shows from a distance that this is a first-class home.

- + Elegant lighting when stationary
- + Durable LED technology
- + Can be retrofitted to vehicles from model year 2019

**EXPERT ADVICE**

**STABILITY + SECURITY**



**VB-AIRSUSPENSION FOR OPTIMAL DRIVING COMFORT, INCREASED STABILITY AND MORE SAFETY**

Anyone who is on the road for hundreds of kilometers at a time naturally wants a stable and comfortable vehicle. It is therefore particularly important that the chassis system is technically in perfect condition.

With our intelligent air suspension systems and spring adjustments, your MORELO remains stable and steerable under all circumstances. A constant driving level is guaranteed.

The vehicle becomes less sensitive to side winds and bumps in the road, offers a more stable cornering position and reacts optimally to sudden evasive and braking manoeuvres, even with heavy and uneven loads.



[www.vbairsuspension.com](http://www.vbairsuspension.com)



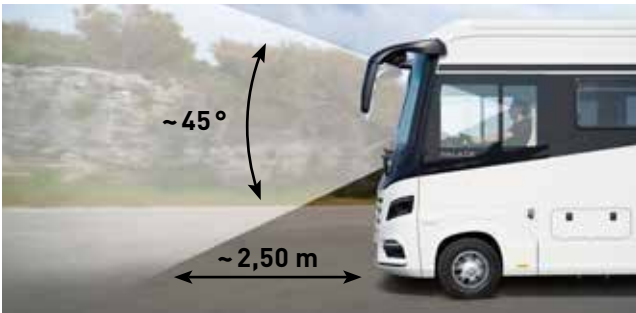

**AT A GLANCE**

The cockpit offers a panoramic view of the road and the landscape. The elevated seat position gives you an expansive overview. The shifting lever and control elements are positioned ergonomically and let you focus on driving.

**PANORAMIC FIELD OF VIEW**

The slim design of the high-strength A-pillar provides you with an optimum view of the road.

- + Large panorama windscreen
- + Optimum field of view
- + High-quality bus-style windscreen wipers

**ALL-ROUND VISIBILITY**

The optimised seat position in the MORELO allows you to see more of the road and to get to your destination safely.

- + A total of six exterior mirrors (From LOFT model)
- + Significantly shortened sight lines
- + Better ability to check blind spots"



**LUXURY CAB SEATS**

A MORELO lets you stay relaxed, even during long journeys, thanks to elegant built-in seats.

- + Belt integrated
- + Extensive adjustment options
- + Adjustable armrests

Images and descriptions may contain options that are subject to surcharge.

**EXPERT ADVICE**

THE ADVENTURE STARTS HERE



**OPERATION, NAVIGATION AND ENTERTAINMENT. ONE SYSTEM**

VIEO™, the fully integrated RV infotainment system. It combines Garmin navigation and premium Fusion® entertainment technology with a 10" portable display.

The display can be removed from the stereo and used as a remote throughout the interior and exterior of the RV, offering full media integration. Its RV-specific navigation features voice control, driver alerts and Camping-POI with detailed information.

When paired with a compatible smartphone, the Garmin Drive™ app connects to provide smart notifications, address sharing, weather- and traffic information.

**GARMIN®**

[www.garmin.com](http://www.garmin.com)





### **PULL-OUT TABLE**

This table can be enlarged and extended lengthwise or crosswise in seconds for maximum flexibility in your living room.



### **LEVEL LIVING ROOM FLOOR**

All one level, from the bedroom all the way to the cockpit. We don't want anyone tripping.

- + High-quality PVC flooring
- + Genuine parquet look
- + No steps

### **PANORAMA SKYLIGHT**

The panorama skylight provides fresh air and plenty of natural light while still being a picture of elegance.

- + Blackout and roller insect screen
- + Optionally for the bedroom
- + Stylish design



### GLASS CABINET

For luck, it does not need shards.

We have designed a glass cabinet which ensures that champagne flutes and wine glasses remain quiet during the ride and exactly where they belong.



### HOT WATER TO HEAT THE FLOOR

Maximum efficiency thanks to the hot water lines carefully integrated into the floor insulation.

- + Adjustable heat output
- + Extremely even heat distribution
- + First-class convenience and maximum comfort

### FRESH WATER SYSTEM

For optimal water pressure, we install a particularly high-performance, quiet pressure water pump.

- + Frost-proof in a heated double floor
- + Central distribution
- + Large water tanks





### BAR SEATING GROUP

Up to five seats with safety belts, a premium glass wall unit and plenty of legroom allow you to relax with friends and family.



### SELF-SUPPORTING TABLE WITH PULL-OUT

We opted to exclude table legs and provide you with a pull-out table so you have maximum space and legroom.

- + Maximum legroom
- + More space thanks to a pull-out extension
- + Numerous designs

### INTEGRATED DRAWERS

Thanks to the drawers integrated into the lounge bench, you can use the storage space without having to remove the upholstery.

- + Additional stowage space
- + Easy to use
- + Optimal accessibility



### REMOVABLE LEATHER STEERING WHEEL

It feels good, looks good and provides maximum freedom of movement. (optional)

- + Elegant leather
- + Unbeatable anti-theft protection
- + Convenient swivel driver's seat

Images and descriptions may contain options that are subject to surcharge.

### EXPERT ADVICE

## SIZE IN DETAIL



### MOBILE TELEVISIONS

All TV sets in your MORELO are manufactured by alphonics, located in Nuremberg, Germany. This means consistently high quality that meets your expectations for a reliable mobile television.

The devices are equipped with power-saving alphonics wide-angle displays, integrated triple tuner (DVB-S2, DVB-T2, DVB-C with CI + for receiving Pay TV), DVD player (depending on model) and Bluetooth 5.1 module. Other standard features include SMART TV capability on the Android operating system and the unique and excellent sound quality.

### OUR ADVICE

Simply put your favourite films on a USB stick and bring them on holiday with you. You'll be entertained throughout the trip, all thanks to alphonics.

alphonics

[www.alphonics.de](http://www.alphonics.de)





### ERGONOMIC SEAT CUSHIONS

Two layers of cold foam with differing firmness levels ensure that you'll be able to sit in comfort for years to come.

- ✚ Multi-level design
- ✚ Ergonomic cold foam
- ✚ High-quality seam work

### SPACIOUS OVERHEAD CABINETS

The overhead cabinets are placed a few millimetres away from the wall of the vehicle, providing perfect ventilation in the back and ensuring an absolutely dry stowage area.

- ✚ Optimal air circulation
- ✚ Open shelves
- ✚ Removable inserts

**LUXURY DOWN TO THE FINEST DETAIL**

How does a motorhome become a MORELO? With sophisticated features such as the shiny chrome accents, the high-quality surfaces and the excellent lighting.



**SATELLITE TV SYSTEM**

The optional satellite TV system with fully automated alignment provides the best entertainment even while you're traveling.

- + 27 to 40" ultra-flat screen
- + Fully automated satellite dish alignment
- + Large reception range

**EXPERT ADVICE**

**THE NEW OYSTER® V**



**SATELLITE SYSTEM**

When you buy a satellite system from ten Haaft, you acquire more than just a reliable brand product. You are also choosing our many years of experience, excellent service, intelligent technology and top quality!

Many service centres throughout Europe ensure reliability and rapid assistance.

**OUR ADVICE**

Oyster® V – the new satellite system with app control, GPS, compass and inclinometer. This system focusses securely on the satellite without searching and provides first-class convenience.



Innovative Mobile Technology

[www.ten-haaft.com](http://www.ten-haaft.com)





### SAFE

Do you want extra security for your valuables? The electric safe with number code lock integrates discretely into the wardrobe and is a fixed, seamless part of the design.



### VACUUM CLEANER (OPTION)

The practical Dyson V8 Absolute convinces as a bagless vacuum cleaner with excellent suction power in a compact size.

- + Without cables – can be used anywhere
- + Patented cyclone technology
- + Hygienic container emptying

### ROLLER BLIND SYSTEM

All windows are equipped with blackout blinds to protect you from the sun and ensure that you can relax during evening free of mosquitoes.

- + Includes insect protection
- + Adjustment to any position
- + High opacity



## KITCHEN

Cooking should be fun. Which is why we offer many options for you to design your very own dream kitchen:

- + Microwave with grill and baking function
- + Luxury dishwasher
- + Roof window fan

Images and descriptions may contain options that are subject to surcharge.

## EXPERT ADVICE

# COMPRESSOR REFRIGERATOR

## DOMETIC RCD 10.5XT WITH DOUBLE-HINGED DOORS AND 142 L CAPACITY

Elegant design meets comfort. Versatile application options with identical dimensions as the gas/230 V/12 V refrigerator and intuitive operation via the TFT display. The compressor technology ensures perfect cooling performance, even at outside temperatures of up to 38 °C, combined with low energy consumption. The integrated booster function allows for fast cooling.



All in all, this is a refrigerator with outstanding performance.

**DOMETIC** **OUTDOOR**

[www.dometic.com](http://www.dometic.com)





### ELECTRICAL CENTRE

The VDE-tested electrical centre ensures an interference-free supply of power, just like you have at home. All supply, measuring and fuse protection points are clearly arranged in one place—exactly like the equipment in your home.

### SAFETY SHUT-OFF

This increases the lifetime of the batteries significantly. The safety shut-off ensures that the batteries are disconnected from the system before damage results from a deep discharge.



### CONTROL PANEL

The control panel with touchscreen keeps you updated with the information about your MORELO you want to know.

- + Easy to operate
- + Central control system
- + Stainless steel frame



### PETROL GENERATOR (OPTIONAL)

The TEC 29 petrol generator from Dometic with 2.6 kW supplies 230 V reliably when there is no mains supply available.

- + Compact and lightweight design
- + Efficient and quiet in operation
- + Stable voltage for sensitive devices



### BATTERY COMPUTER

The available capacity of the on-board batteries and the power consumption you always have in view thanks to the battery computer.

- + In Combination with Charging / inverter combination
- + Display of the remaining capacity in percent
- + Amperage, voltage and remaining time

Images and descriptions may contain options that are subject to surcharge.

### EXPERT ADVICE

# 340 AH LITHIUM BATTERY



### THE NEW GENERATION

The new Nomia 12V340Ah is a rechargeable lithium iron phosphate battery with a nominal capacity of 340 Ah. Compared to conventional gel batteries, it offers enormous weight and space savings.

**Low maintenance**

**Fast charging**

**High discharge current**

**Low self discharge**

**High capacity**

**High charge cycles**

Comparisons show that the energy density of the Nomia 12V340Ah lithium iron phosphate battery is seven times higher than a standard 160 Ah gel battery.



[www.super-b.com](http://www.super-b.com)





### SOLAR SYSTEM

Let the sun work for you. Each module is capable of storing 130 watts, enabling you to benefit from this free energy to charge the vehicle batteries.



### GAS LOCKER

The GRP locker is fully insulated, waterproof and provides stowage space for two gas bottles of 11 kilograms each.

- + Automatic toggle function
- + Full insulation from the living area
- + Easy to clean



### CHARGE BOOSTER

Always the optimum charging power, even for short distances. Full utilisation of battery capacity even in extreme weather conditions.

- + Full charge even at low speed
- + High charging power
- + Charge with IUoU charging characteristic

## ELECTRICAL PACKAGES

Those looking to travel with complete self-sufficiency in their MORELO should take a closer look at the energy package options.



## POWER CENTER

A powerful energy central ensures comfort on board. Even sensitive household appliances can be operated without any problems.

- + 230 V always and everywhere
- + Battery charge up to 120A possible
- + Power shortage compensation

Images and descriptions may contain options that are subject to surcharge.

EXPERT ADVICE

# BECOME INDEPENDENT

## HIGH-PERFORMANCE SOLAR MODULES FOR YOUR MORELO

With the Black Line modules from Büttner Elektronik, you have a reliable energy supplier on your roof in every situation. The special feature of these high-performance modules are the 72 cells and the associated multicell technology. Compared to conventional 36-cell modules, the Black Line plays its cards even in difficult weather conditions or in partial shade.

**BÜTTNER**  
ELEKTRONIK  
GERMANY

**DOMETIC**

[www.buettner-elektronik.de](http://www.buettner-elektronik.de)







### SUPPLY TECHNOLOGY

Household pipes with a large cross-section ensure a water flow free of problems. For optimal weight distribution, the tanks are located in the middle of the vehicle, protected from frost and freezing by the heated double floor.



### WATER TANKS

Innovative air-tight rectangular tanks, including supply lines and tank venting, are located at the strut mount, allowing for complete filling.

- + Easy filling
- + Air-tight design helps prevent algae build-up
- + Expandable tank volume

### WASTE WATER OUTLETS

We install household-quality pipes and large outlets with ball valves so that you can get rid of waste water quickly and easily.

- + Quick emptying
- + Prevents the release of odours
- + Optionally with electric functionality



**GAS TANK**

Become even more independent: depending on the vehicle type, a gas tank with up to 150 liters (= approx. 55 kg) is possible



**THE SYMBIOSIS OF FUNCTION AND DESIGN**

An outstanding motorhome is much more than the sum of its individual highlights. We give more consideration to this interaction than any other manufacturer. This is because we build luxury motorhomes out of conviction but we also enjoy driving them across Europe with the passion to visit every spot. For testing and for the pure joy of the ride.

- + Longest possible model lifecycles
- + Load capacity suitable for real-world use
- + Rugged design
- + Carefully selected suppliers
- + Decades of experience in theory and practice
- + Continuous refinement





### ➤ HEATING ELEMENTS

Heating elements in front of the windscreen protect against cold entering the vehicle and efficiently prevent the windscreen from fogging up.

- Acts like a curtain of heat
- Optimised room climate
- Clear road visibility

### ➤ HEATED DOUBLE FLOOR

Thanks to perfect insulation and ideal placement of convectors, tanks and supply lines are positioned to prevent freezing.

- Water tanks protected from freezing
- Prevention of condensation
- Even heat distribution in the vehicle



### **3 LIVING ROOM HEATING ELEMENTS**

Throughout the living room, several heating elements make efficient use of energy to ensure the MORELO comfort climate you have come to expect.

- + Perfect circulation
- + Hand towel dryer (depending on model)
- + Sleeping space and garage adjustable separately

### **4 HOT WATER CENTRAL HEATING**

A relaxing shower is no problem in a first-class MORELO motorhome thanks to the high-performance hot water central heating system.

- + Gas-operated 5.8 kW heat output
- + Electric heat output up to 3 kW
- + Integrated boiler





### ➤ ELEVATED CAB

The high-strength steel design works with the double floor to create a level living room floor with the cockpit fully integrated into the living area.

- Perfect overview thanks to elevated driver position
- Driver's seat above the impact area of a typical car
- Underride guards in accordance with standards

### ➤ STANDALONE INSTRUMENT PANEL

The standalone instrument panel is optimally adapted to the inner width of the motorhome and the needs of the driver and passenger.

- Perfect driver seating position
- 20 cm wider passage to the front
- Cosy ambience



### **3 SPACIOUS LIVING ROOM**

The living room windows with smooth exterior, interior roller blinds and specially built-in heating elements provide a one-of-a-kind living room size.

- + Measurably more space than the competition
- + Bathroom can be used by two people at once
- + Tempered glass living room windows (opt.)

### **4 VOLUMINOUS STORAGE SPACES**

All MORELO motorhomes feature amazing stowage space availability in the double floor and large scooter or car garage.

- + Underfloor stowage space height of 366 to 480 mm
- + Heated stowage spaces and rear garage
- + Garage for cars from Smart to Mini Cooper





### **1 VARIABLE LIVING ROOMS**

MORELO first-class motorhomes feature spacious living environments as well as comfortable, ergonomically designed cushions.

- + Lounge seating group or bar version
- + Microfibre or leather upholstery
- + Tested 3-point belt system

### **2 A KITCHEN FIT FOR A HEAD CHEF**

Exceptionally high-quality, durable materials, real-world suitability and attention to every detail define every MORELO kitchen.

- + Extra deep kitchen cupboards and drawers
- + Kitchen worktop with double sink
- + High-quality built-in appliances



### **3 WELL-BEING WHILE TRAVELLING**

A generously dimensioned bathroom, ample water supply and toilet with built-in tank combine to provide the bathroom comfort.

- + Large water tanks
- + Toilet with built-in tank or cassette toilet
- + Home-quality shower

### **4 SLEEP FIT FOR ROYALTY**

Cosy beds, outstanding sprung base with ventilation and perfectly matched multi-zone comfort mattresses let you sleep like at home.

- + 5-zone comfort cold foam mattresses
- + Spot-elastic comfort springs
- + Optional TV in bedroom



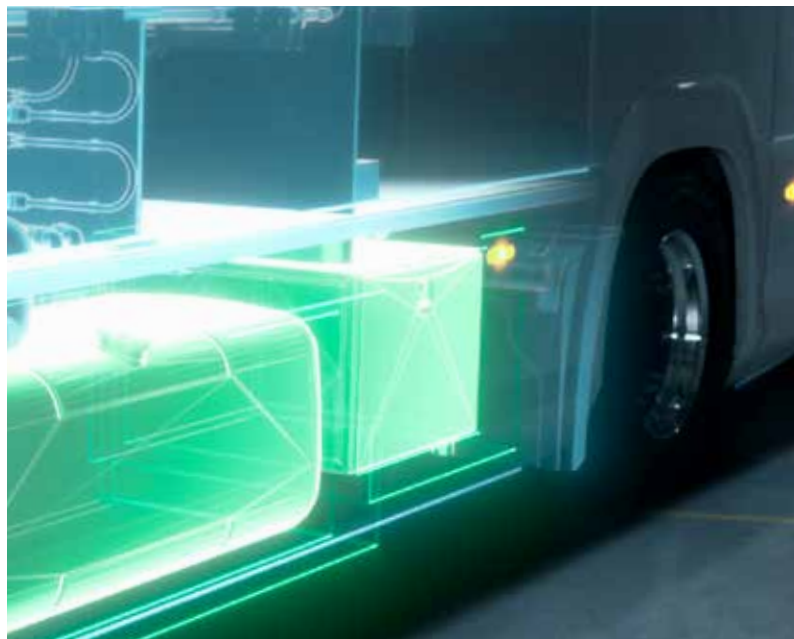

### POWER BOX

The entire power supply system is fitted inside a space-saving, insulated and heated stainless steel power box underneath the vehicle.

- + Lithium-iron phosphate battery 4 x 210 Ah
- + Mounted on a convenient sliding system
- + More space in the double floor

### FUEL HEATER

A heating system that is setting new benchmarks in terms of heating performance, powered by a 500 l diesel tank. And what's best: you won't hear a thing.

- + 10/17 kW with multi-circuit system
- + With flow heater
- + Compact installation underneath the vehicle

**A POWERHOUSE THAT GETS YOU FURTHER.**

The Mercedes-Benz Actros 1853 is not only a hugely powerful engine, it also incredibly efficient. In our tests, the outstanding motorhome consumed a surprisingly low level of diesel.



**SEATING COMFORT**

Reach your destination feeling truly relaxed. The air-sprung driver's cab seats provide extraordinary comfort, while also being a true eye-catcher.

- + ROYAL leather upholstery
- + With lumbar support
- + Heated and ventilated seats

**MIRRORCAM**

New mirror technology: The MirrorCam system not only replaces the traditional rear-view mirrors, but is capable of a lot more – particularly when it comes to safety.

- + Improved visibility around the A pillar
- + Perfect view thanks to pivoting cameras
- + Aerodynamic and fuel-efficient





## KITCHEN

When you enjoy your kitchen and culinary delights, cooking becomes a pleasure. The GRAND EMPIRE offers the ideal conditions for this.

- + Clever ergonomic space concept
- + Kitchen worktop made from mineral substance
- + Luxury dishwasher

## 230 VOLT POWER SUPPLY

Just like at home. This is what life in a GRAND EMPIRE should feel like. This also includes high-performance power supply for household appliances.

- + Induction cooker and built-in compact oven
- + 196 litre refrigerator
- + Sockets, 3 x 230 V and 1 x USB charging



### PURE RELAXATION

Put your feet up at the touch of a button in the luxury lounge with the ergonomic ROYAL leather upholstery.

- + Comfortable multi-layer construction
- + Various massage programmes
- + Multi-level seat heating

Images and descriptions may contain options that are subject to surcharge.

### EXPERT ADVICE

## CLEAR BENEFITS



### WE PROVIDE A CLEAR VIEW

Whether single-pane or laminated safety glass, our over 33 years of experience mean that we offer optimum support for stone chips, cracks or breakage.

**Mobile replacement of all windows in your motorhome – even at your holiday destination**

**Stone chip repairs**

**Motorhome glass in OEM quality**

**Experienced and specialised fitters**

**Support with insurance issues**

**All services guaranteed**

A small stone chip or a large crack? Repairing, conditioning or replacing the glass pane? We are in a class of our own when it comes to motorhome glazing. We will gladly support you and your MORELO motorhome at your holiday destination, regardless of whether you are in Trieste, Trondheim or Tarascon.

**ZENTRALE  
AUTOGLAS**  
**Die Womo Profis**

[www.zentrale-autoglas.de](http://www.zentrale-autoglas.de)





»We are the proud owners of a  
**MORELO PALACE 85 L.**«



## » AT HOME ALL OVER THE WORLD «

---

**We have made the right choice.** After countless travels as enthusiastic globetrotters, we longed for a moveable residence. So when we looked around the market in 2016, we quickly realised that only one provider could fulfil our individual wishes: MORELO. Thanks to the fantastic advice and attention to detail, our motorhome became our very own personal home.

When we were allowed to pick up our MORELO PALACE in Schlüsselfeld a short time later, we immediately set off on our first journey. Since then, we have been exploring all of Europe: whether it's the Portuguese coast or the Tyrolean mountains – with our beloved PALACE, we switch between worlds. So at breakfast we are still sitting in the winter paradise of St. Moritz and a few hours later in the Italian spring on Lake Maggiore. We only have to open the door of our MORELO and the world is at our feet in all its beauty.

We have big plans for our next adventure: We want to go to South America with our PALACE. A trip we have been dreaming of for a long time. At MORELO we don't just feel like normal customers. At MORELO we are part of a big family. A family that travels all over the world and always feels "at home" – for us, that means "welcome home".

Gundula & Friedrich Buntz from Obersontheim, Germany



Vehicle model: **MORELO PALACE 85 L**  
 Chassis: **IVECO Daily 70 C 17**  
 Purchase date: **December 2016 in Schlüsselfeld**  
 Receipt: **January, 25<sup>th</sup> 2017 in Schlüsselfeld**  
 Trip distance: **approx. 80,000 km**  
 Favourite destinations: **Sylt, Kitzbühel, South Tyrol, Engadine**  
 Equipment: **ZF 8-speed converter gearbox, diesel heating, 630 l fresh water, additional solar panels, several lithium batteries and much more**  
 Always on board: **Bikes, skis, a good mood and a desire to discover the whole world!**







# FROM ENTHUSIASTS FOR FANS

---

**State-of-the-art production technology and traditional craftsmanship and everything best-in-class:** This is what a first-class motorhome is made of. A MORELO is what happens when motorhome enthusiasts like us and exclusive motorhome fans like you bring your dream of luxury on wheels to life with passion, dedication and enthusiasm. Made in Germany and first class.



## VB-AIRSUSPENSION

This air suspension specialist makes our motorhomes even safer and more convenient thanks to improved roadholding and optimised stability. Numerous additional functions turn quality into premium quality.

[www.vbairsuspension.co.uk](http://www.vbairsuspension.co.uk)



## IVECO

We build on a stable foundation. The IVECO chassis ensures absolute brand-name quality. Rugged, stable and durable—we and our partners are so confident of this that we give you a two-year mobility guarantee.

[www.iveco.com](http://www.iveco.com)



## TEN HAAFT

Outstanding satellite systems for a diverse range of programmes and top-class convenience is yours thanks to Ten Haaft. Exceptional service, intelligent technology and top quality on all channels for your entertainment.

[www.ten-haaft.com](http://www.ten-haaft.com)



## DOMETIC

"Mobile living made easy" is the on-board motto at MORELO. Dometic equips our motorhomes with innovative and high-quality solutions to make life on the road more comfortable – from lighting systems, to roof-mounted air conditioning units, to refrigerators.

[www.dometic.com](http://www.dometic.com)



## FAHRZEUGBAU MEIER

Fahrzeugbau Meier is our authority of choice in all things related to safety. Such as the combination of the smart ActiveAir suspension and damping system and the newly developed front axle for the IVECO Daily that is 200 mm wider.

[www.fahrzeugbau-meier.de](http://www.fahrzeugbau-meier.de)

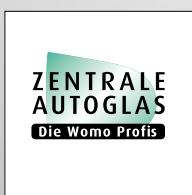

## ZENTRALE AUTOGLAS

When it comes to stone chips and window replacements, Zentrale Autoglas are specialists you can trust. As experienced installers, we ensure safety and crystal-clear views from your MORELO first-class motorhome.

[www.zentrale-autoglas.de](http://www.zentrale-autoglas.de)



## LIVING ROOM

The standard lounge is equipped with ergonomic seat cushions, a pull-out table and a glass case with LED lighting. Numerous other layouts offer a wide array of customisation options.

We are certain that you will find the MORELO layout that is perfect for you.



### "Lounge" living room

The seating quality is right on par with the showcase quality for these comfortable, ergonomically shaped cushions. The enormous windows allow plenty of light into the living room.



### Long bench

Do you need a little bit more? All floor plans labelled with a "B" mean the vehicle is equipped with a longer bench which provides more space and stowage room in the living space.



### "Bar" living room (optional)

The "Bar" living room variant offers space for friends and family and increases the number of seats with safety belts from four to five.



### "Novel" living room (optional)

The extra large lounge seating group has been opened towards the room with the kitchen connected to it directly. This creates an elegant line throughout the entire vehicle.

## BATHROOM

Different customer requests require different bathroom variants.

This is why MORELO offers various bathrooms depending on the vehicle, from compact to spacious and even with the option of a separate toilet room.



### Spacious bathroom (HOME and LOFT models)

The separate toilet room offers a plus for privacy and enables flexible use of the bathroom by several people.



### F-bathroom (LOFT models)

The perfect partner for your double bed. The F-bathroom is not only a luxuriously equipped bathroom, but also provides first-class access to the bedroom.



### Premium bathroom

The premium bathroom offers plenty of room to move and numerous stowage options. The two-piece sliding door to the bedroom is mirrored.



### Luxury bathroom

The separate toilet room with window and roof window provides additional privacy while enabling the bathroom to be used by multiple people simultaneously.



## BEDROOM

Three bed variants are available for the bedroom equipment.

Cold-foam mattresses with spot-elastic springs (model-dependent) provide optimum support and ensure optimum sleeping conditions thanks to integrated ventilation.



### Queen bed (M)

The queen bed is accessible from both sides and provides enough room for two additional wardrobes.

Convenient size: **approx. 163 x 200 cm**



### Front-to-back bed (L)

The front-to-back bed maximises your available space and is available as a double bed or two separate beds.

Premium size: **Two times approx. 106 x 200 cm**



### French bed (F) (depending on model)

Ideal for everyone who wants to be close to their partner at night and delights in having an additional wardrobe.

French-style bed dimension **approx. 158 x 195 cm**

**BEDROOM OPTIONS**

Personalisation plays no bigger role than when it comes to choosing the perfect bed. Which is why we will gladly help you to adapt your bedroom to your exact sleeping requirements. Whether you want a drop-down bed or an extra-wide bed, we will help make sure you have a relaxing night.

**Drop-down bed** (optional)

Turn your motorhome into a comfortable sleeping space and back into a cosy living room at the touch of a button.

**Lying area for M-bed** (optional)

For those who like things a little cosier, the comfortable lying area is the perfect solution. This option also provides two wardrobes.

**Separate L-bed** (optional)

The separate L-bed has room for two people and guarantees easy access.

**Lying area for L-bed** (optional)

Upon request, we can turn your front-to-back bed into an expansive comfort zone which covers the entire width of the vehicle.



**KITCHEN COUNTERTOPS**

The Morelosan kitchen countertop with seamlessly integrated sink and drying basin is functional and very easy to clean thanks to the smooth form free of joints or edges. High-quality mineral material surface countertops are available as special equipment.



**Morelosan** Salt



**Morelosan** Zimt



**Mineral material surface** Creme



**Mineral material surface** Pepper

**VELOURS OR SISAL LIVING ROOM FLOORS AND FLOOR COVERINGS**

The surface of the floor coverings are easy to clean while remaining exceedingly durable and long-lasting. The optional carpet variants in sisal and velours quality give a pleasant atmosphere to the living space



**Living room floor** Cappuccino



**Living room floor** Dark Grey



**Carpet Velours** Grey-brown



**Carpet Velours** Chocolate



**Carpet Velours** Beige



**Carpet Sisal** Sierra



**INTERIOR SURFACES**

Light or dark? Or rather, "Life" or "Trend"? The choice is yours between elegant palisander and contemporary aralia. For an atmosphere of timeless elegance, we recommend our "Cashmere" style for LOFT and PALACE models: with light grey cabinet fittings and light aralia.



**Furniture wood colour** Trend



**Furniture wood colour** Life



**Wall covering** Standard



**Wall lining** Synthetic leather

### COLOUR SCHEME

Design your motorhome to suit your very own tastes!

We will gladly assist and support you and will show you the best material combinations for surfaces, cushions and decoration.



### CUSHION: LEATHER

For the optional leather equipment, MORELO uses soft yet strong cowhide with an elegant surface structure. The surface repels dirt and can be easily cleaned with a moist towel as needed.

### CUSHIONS: LEATHER/FABRIC COMBINATION

Combining leather and fabric joins two contrasting types of materials to form one modern surface look. The surfaces of the seat and backrest are covered in fabric with cushion skirts of leather. The effect can be emphasised by selecting corresponding colours.

### CUSHIONS: MICROFIBRE

Ergonomically shaped cushions with diol padding offer outstanding sitting comfort.

The Teflon-coated microfibre surface repels dirt and is extremely durable.

Zippers let you change the coverings for thorough cleaning.



**TABLE IN THE LIVING ROOM**

The living room table is available in five different finishes. Lacquered real-wood frames and durable, scratch-resistant laminated surfaces offer maximum quality.



**Tabletop** Viva



**Tabletop** Lava



**Tabletop** Stone



**Tabletop** Quarz, table edge Trend



**Tabletop** Granit, table edge Life

**SELECTED DRAPERY MATERIALS**

Your MORELO is customised as you wish.

Of course, this also includes picking your favourites from among the material patterns.



**Pleated blinds** Standard from HOME to PALACE LINER



**Sliding curtains** Standard GRAND EMPIRE, option from HOME to PALACE LINER



**Venetian blinds** Option from HOME to PALACE LINER



**Venetian blinds** Standard EMPIRE LINER



**Pattern 200**



**Pattern 230**



**Pattern 330**



**Pattern 340**



**Pattern 700**





# WELCOME HOME!

**Celebrate with us at the traditional MORELO family reunion on Ascension Day.** One thing is certain: boredom has no chance here! Exciting days await you, packed with many highlights and a good mood. Motorhome fans of all brands are warmly invited to our MORELO OPEN.

WELCOME HOME at MORELO in Schlüsselfeld! ♥

 **MORELO OPEN 2023:** Thursday 18 May to Sunday 21 May





WELCOME HOME







**MORELO**  
FIRST CLASS REISEMOBILE

**MORELO Reisemobile GmbH** · Helmut-Reimann-Straße 2 · D-96132 Schlüsselfeld · Fon: +49 (0) 95 52 - 9296 00 · [www.morelo-reisemobile.de](http://www.morelo-reisemobile.de)

Subject to corrections and technical changes. Note that some of the images in this catalogue show alternative designs or special equipment that incur extra costs.  
Deviations in colour are possible from printing. Reproduction in whole in or part permitted only with the express permission of MORELO Reisemobile GmbH.

made with  by BRANDORT